



BCD600





















ICE BIN WITH CART FOR MODULAR MACHINES

FEATURES CARATTERISTICHE

- ▶ **ICE BIN CAPACITY OF 617 KG (CART CAPACITY NOT INCLUDED).**
SERBATOIO PER GHIACCIO CON CAPACITÀ DI 617 KG (CAPACITÀ DEL CARRELLO NON INCLUSA).
- ▶ **AISI 304 STAINLESS STEEL BIN.**
SERBATOIO DI ACCIAIO INOSSIDABILE QUALITÀ AISI 304.
- ▶ **HARD SANITARY POLYETHYLENE VAT, RESISTANT TO BLOWS, AND SCRATCHES.**
CISTERNA INTERNA DI POLIETILENE SANITARIO DI ELEVATA DUREZZA, RESISTENTE AD URTI E ATTRITI.
- ▶ **EASY CLEANING DESIGN®: SEAMLESS ONE-PIECE VAT WITH ROUNDED CORNERS, AVOIDING POSSIBLE DIRTY POINTS AND FACILITATING CLEANING.**
EASY CLEANING DESIGN®: CISTERNA INTERNA SENZA GIUNZIONI, IN UN UNICO PEZZO, CON ANGOLI ARROTONDATI PER ELIMINARE EVENTUALI PUNTI DI SPORCIZIA E FACILITARE LA PULIZIA.
- ▶ **DRAINAGE SYSTEM THAT COLLECTS AND DRIVES THE WATER TO THE DRAIN KEEPING THE BIN AND FLOOR CLEAN & DRY.**
SISTEMA DI DRENAGGIO CHE RACCOGLIE E CONDUCE L'ACQUA ALLO SCARICO MANTENENDO IL SERBATOIO E IL PAVIMENTO PULITI E ASCIUTTI.
- ▶ **LARGE CAPACITY EASY CART®, UP TO 112 KG OF ICE (70 KG WITH BUCKETS); ERGONOMIC, EASY TO MOVE WITH LITTLE EFFORT.**
EASY CART® CON ELEVATA CAPACITÀ, FINO A 112 KG DI GHIACCIO (70 KG CON CESTELLI) ED ERGONOMICO, FACILE DA SPOSTARE CON IL MINIMO SFORZO.
- ▶ **EASY CART® HAS A BRAKING AND DRAINAGE SYSTEM.**
EASY CART® DISPONE DI SISTEMA FRENANTE E SCARICO.
- ▶ **EASY CART® IS MADE OF SANITARY POLYETHYLENE, WITH SMOOTH SURFACE TO FACILITATE CLEANING. IT INCLUDES A COVER TO PREVENT DIRT FROM CONTAMINATING THE ICE.**
EASY CART® IN POLIETILENE SANITARIO, SENZA RUGOSITÀ PER FACILITARE LA PULIZIA. INCLUDE COPERCHIO PER EVITARE CHE LA POLVERE CONTAMINI IL GHIACCIO.
- ▶ **BUCKETS FOR DISTRIBUTING ICE QUICKLY AND EFFORTLESSLY CAN BE INCLUDED.**
SI POSSONO INCLUDERE CESTELLI PER DISTRIBUIRE IL GHIACCIO RAPIDAMENTE E SENZA SFORZO.



RECOMMENDED MACHINES MACCHINE RACCOMANDATI

	SS/SK	FD/HD	PS	GR	SC
 RECOMMENDED RACCOMANDATO	 2 SS150  SS400	 2 FD/HD 215  112 FD/HD 415		 1 12 GR 400  1 12 GR 560  1 12 GR 560 SPLIT  GR 850 CO2 SPLIT  GR 1100  GR 1100 SPLIT	 SC 400  SC 600  SC 1TN / SC 1.5TN / SC 2TN / SC 3TN SPLIT
 NOT RECOMMENDED NO RACCOMANDATO	 SS150	 FD/HD 215  FD/HD 315 SLIM		 1 12 GR 220  2GR 850 CO2 SPLIT	 SC 1T



BCD 600

RIGHT SIDE VIEW
VISTA LATERALE DESTRA

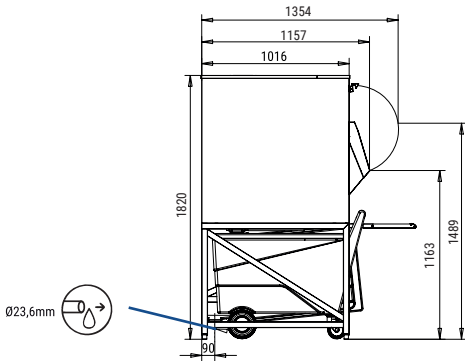

FRONTAL VIEW
VISTA FRONTALE

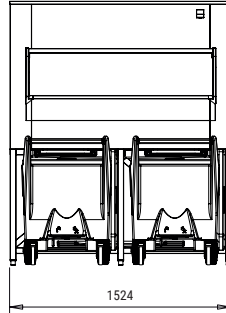

REAR VIEW
VISTA POSTERIORE

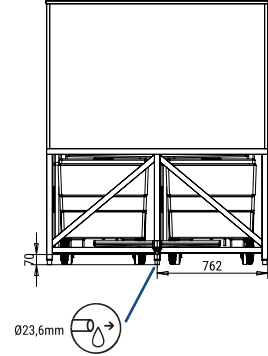

UPPER VIEW
VISTA SUPERIORE

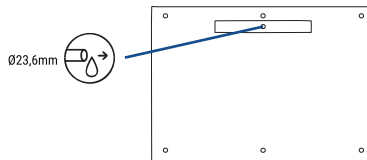

*All measurements in mm.
*Tutte le misure in mm.

ACCESSORIES ACCESSORI

INCLOSO



WATER OUTLET HOSE
TUBO DI SCARICO



LARGE SCOOP
PALA GRANDE



ICE PADDLE
PALA CON MANICO LUNGO



ICE PADDLE SUPPORT
SUPPORTO PER LA PALA

NON INCLUSO (OPTIONAL)



BUCKETS
CESTELLI



(Kg)



(Kg)



(Kg)



(mm)



(Kg)



(mm)



(Kg)

(m³)

BCD 600

617

494

841

Width 1.524
Depth 1.016*
Height 1.820

160

Width 1.630
Depth 1.240
Height 1.980

255

4



ICETECH, S.A.
POL. IND. LA REVA, SECTOR 13, AV. GREMIS, 1
46394 RIBARROJA DE TURIA, VALENCIA, SPAIN
PHONE: +34 961 667 636 | FAX: +34 961 668 944
sales@icetechice.com | www.icetechice.com



SERVICE
SERVIZIO ASSISTENZA TECNICA
sales@icetechice.com
Skype: ICETECH.Service
+34 961 667 639
8:00AM | 7:00PM



Subject to certain limitations
and exclusions. Only spare parts.
Soggetta a limitazioni e revoca.
Solo parti di ricambio.

