



BCD800













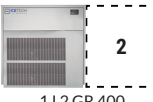



ICE BIN WITH CART FOR MODULAR MACHINES

FEATURES CARACTERÍSTICAS

- ▶ **ICE BIN CAPACITY OF 812 KG (CART CAPACITY NOT INCLUDED).**
DEPÓSITO PARA HIELO CON CAPACIDAD DE 812 KG (CAPACIDAD DE LOS CARROS NO INCLUIDA).
- ▶ **AISI 304 STAINLESS STEEL BIN.**
DEPÓSITO DE ACERO INOXIDABLE CALIDAD AISI 304.
- ▶ **HARD SANITARY POLYETHYLENE VAT, RESISTANT TO BLOWS, AND SCRATCHES.**
CUBA INTERIOR DE POLIETILENO SANITARIO DE GRAN DUREZA, RESISTENTE A GOLPES, Y ROCES.
- ▶ **EASY CLEANING DESIGN®: SEAMLESS ONE-PIECE VAT WITH ROUNDED CORNERS, AVOIDING POSSIBLE DIRTY POINTS AND FACILITATING CLEANING.**
EASY CLEANING DESIGN®: CUBA INTERIOR SIN JUNTAS, DE UNA SOLA PIEZA, CON ESQUINAS REDONDEADAS, ELIMINANDO POSIBLES PUNTOS DE SUCIEDAD Y FACILITANDO LA LIMPIEZA.
- ▶ **DRAINAGE SYSTEM THAT COLLECTS AND DRIVES THE WATER TO THE DRAIN KEEPING THE BIN AND FLOOR CLEAN & DRY.**
SISTEMA DE DRENAJE QUE RECOGE Y CONDUCE EL AGUA AL DESAGÜE MANTENIENDO TANTO EL SILO Y COMO SUELO LIMPIOS Y SECOS.
- ▶ **LARGE CAPACITY EASY CART®, UP TO 112 KG OF ICE (70 KG WITH BUCKETS); ERGONOMIC, EASY TO MOVE WITH LITTLE EFFORT.**
EASY CART® DE GRAN CAPACIDAD, HASTA 112 KG DE HIELO (70 KG CON CESTAS) Y ERGONÓMICOS, FÁCILES DE MOVER SIN APENAS ESFUERZO.
- ▶ **EASY CART® HAS A BRAKING AND DRAINAGE SYSTEM.**
EASY CART® DISPONE DE SISTEMA DE FRENADO Y DESAGÜE.
- ▶ **EASY CART® IS MADE OF SANITARY POLYETHYLENE, WITH SMOOTH SURFACE TO FACILITATE CLEANING. IT INCLUDES A COVER TO PREVENT DIRT FROM CONTAMINATING THE ICE.**
EASY CART® EN POLIETILENO SANITARIO, SIN RUGOSIDADES PARA FACILITAR LA LIMPIEZA. INCLUYE TAPA PARA QUE EL POLVO NO CONTAMINE EL HIELO.
- ▶ **BUCKETS FOR DISTRIBUTING ICE QUICKLY AND EFFORTLESSLY CAN BE INCLUDED.**
SE PUEDEN INCLUIR CESTAS PARA REPARTIR EL HIELO RÁPIDAMENTE Y SIN ESFUERZO.

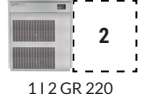

RECOMMENDED MACHINES MÁQUINAS RECOMENDADAS

	SS/SK	FD/HD	PS	GR	SC
 RECOMMENDED RECOMENDADO	 2 SS400	 2 FD/HD 215		 2 1 12 GR 400	 2 SC 400
		 2 FD/HD 415		 2 1 12 GR 560 SPLIT	 2 SC 600
				 2 GR 1100	 SC 1TN / SC 1.5TN / SC 2TN / SC 3TN SPLIT
 NOT RECOMMENDED NO RECOMENDADO	 1 12 SS 150	 FD/HD 215 FD/HD 415		 2 1 12 GR 220	 SC 1T
		 FD/HD 315 SLIM		 2 GR 1100 SPLIT	



BCD 800

RIGHT SIDE VIEW
VISTA LATERAL DERECHA

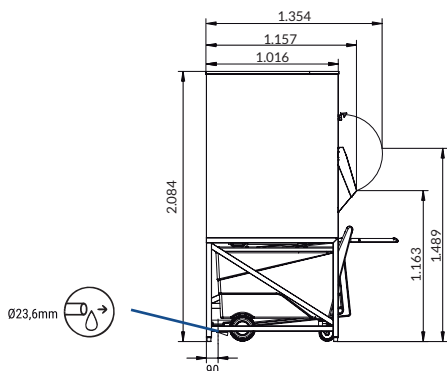

FRONTAL VIEW
VISTA FRONTAL

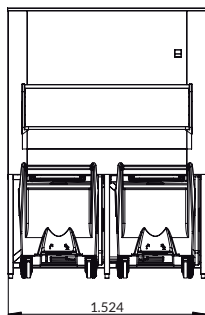

REAR VIEW
VISTA TRASERA

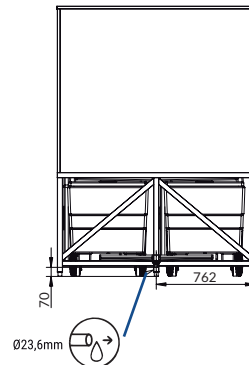

UPPER VIEW
VISTA SUPERIOR

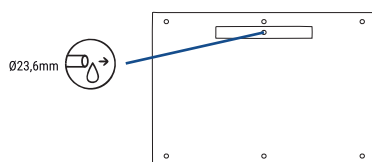

*All measurements in mm.
*Todas las cotas en mm.

ACCESSORIES ACCESORIOS

INCLUDED



WATER OUTLET HOSE
MANGUERA DE DESAGÜE



LARGE SCOOP
PALA GRANDE



ICE PADDLE
PALA DE MANGO LARGO



ICE PADDLE SUPPORT
SOPORTE PARA PALA

NOT INCLUDED (OPTIONAL)



BUCKETS
CESTAS



(Kg)



(Kg)



(Kg)



(mm)



(Kg)



(mm)



(Kg)

(m³)

BCD 800

812

650

1.036

Width 1.524
Depth 1.016
Height 2.084

175

Width 1.630
Depth 1.240
Height 2.240

276

4,53

*WITHOUT DOOR SIN PUERTA



ICETECH, S.A.
POL. IND. LA REVA, SECTOR 13, AV. GREMIS, 1
46394 RIBARROJA DE TURIA, VALENCIA, SPAIN
PHONE: +34 961 667 636 | FAX: +34 961 668 944
sales@icetechice.com | www.icetechice.com



SERVICE
SERVICIO ASISTENCIA TÉCNICA
service@icetechice.com
Skype: ICETECH.Service
+34 961 667 639
8:00AM | 7:00PM



Subject to certain limitations
and exclusions. Only spare parts.
Sujeto a limitaciones y exclusiones.
Solo piezas de repuesto.

