



B 210















ICE BIN FOR MODULAR MACHINES

FEATURES CARACTERÍSTICAS

- ▶ **ICE BIN CAPACITY OF 230 KG.**
DEPÓSITO PARA HIELO CON CAPACIDAD DE 230 KG.
- ▶ **AISI 304 STAINLESS STEEL BINS.**
DEPÓSITO DE ACERO INOXIDABLE CALIDAD AISI 304.
- ▶ **VERY HARD SANITARY POLYETHYLENE VAT, RESISTANT TO BLOWS, AND SCRATCHES.**
CUBA INTERIOR DE POLIETILENO SANITARIO DE GRAN DUREZA, RESISTENTE A GOLPES, Y ROCES.
- ▶ **EASY CLEANING DESIGN®: SEAMLESS ONE-PIECE VAT WITH ROUNDED CORNERS, AVOIDING POSSIBLE DIRTY POINTS AND FACILITATING CLEANING.**
EASY CLEANING DESIGN®: CUBA INTERIOR SIN JUNTAS, DE UNA SOLA PIEZA, CON ESQUINAS REDONDEADAS, ELIMINANDO POSIBLES PUNTOS DE SUCIEDAD Y FACILITANDO LA LIMPIEZA.
- ▶ **DRAINAGE SYSTEM THAT COLLECTS AND DRIVES THE WATER TO THE DRAIN KEEPING THE BIN CLEAN & DRY.**
SISTEMA DE DRENAJE QUE RECOGE Y CONDUCE EL AGUA AL DESAGÜE MANTENIENDO EL SILO LIMPIO Y SECO.



RECOMMENDED MACHINES MÁQUINAS RECOMENDADAS

	SS/SK	FD/HD	PS	GR	SC
  RECOMMENDED RECOMENDADO	 112 SS150	 112 FD/HD 215		 GR 220	 GR 310
		 FD/HD 315 SLIM		 GR 400	 GR 560
		 112 FD/HD 415		 GR 560 SPLIT	 GR 850 CO2 SPLIT
  NOT RECOMMENDED NO RECOMENDADO				 GR1100 SPLIT	

B 210

RIGHT SIDE VIEW
VISTA LATERAL DERECHA

FRONTAL VIEW
VISTA FRONTAL

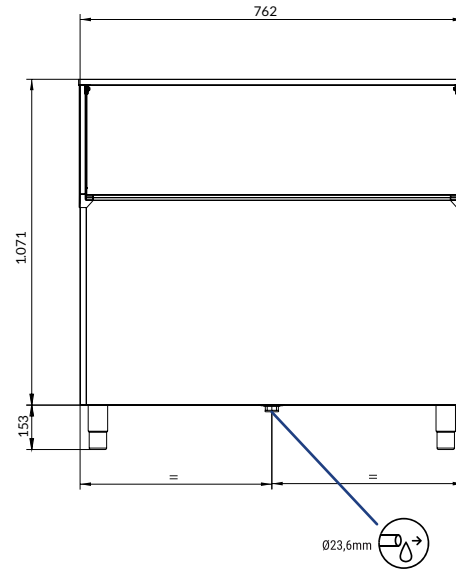
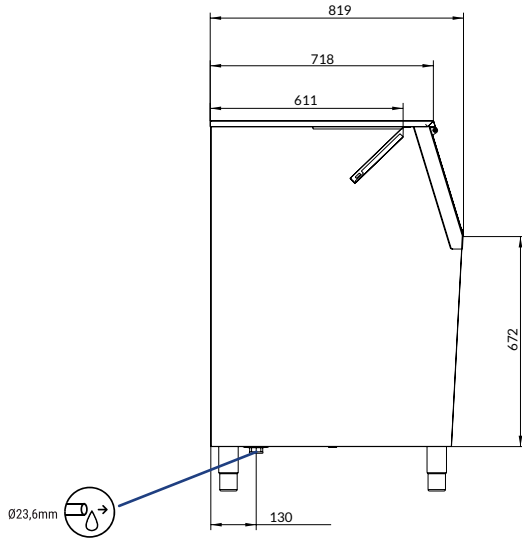

*All measurements in mm.
*Todas las cotas en mm.

ACCESSORIES ACCESORIOS

INCLUDED



4 HEIGHT ADJUSTABLE LEG KIT
KIT 4 PATAS ALTURA REGULABLE



LARGE SCOOP
PALA GRANDE



WATER OUTLET HOSE
MANGUERA DE DESAGÜE



DRAINAGE ELBOW
CODO DE DESAGÜE

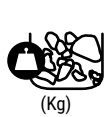

(Kg)



(Kg)



(mm)



(Kg)



(mm)



(Kg)

(m³)

B 210

230

184

Width 762
Depth 819
Height* 1.071

56

Width 850
Depth 890
Height* 1.210

68

0,92

*1.231 mm with legs
*1.231 mm con patas