

FD/HD 100 230 V / 60 Hz











SELF-CONTAINED ICE CUBE MACHINE



FEATURES CARACTERÍSTICAS

- ▶ **PRODUCE FULL DICE ICE CUBES OR HALF DICE ICE CUBES**
PRODUCE CUBITOS DE DADO O MEDIO DADO
- ▶ **STIF: STRONG INOX FRAME. SOLID MACHINE STRUCTURE IN 4 COLUMNS WITH AISI 304 STAINLESS STEEL FRAME**
STIF: STRONG INOX FRAME. MÁQUINA CON SÓLIDA ESTRUCTURA DE 4 COLUMNAS Y CARROGERÍA EN ACERO INOXIDABLE AISI 304
- ▶ **CLEANING SWITCH: ALLOWS CIRCULATION OF WATER WITH DESCALING PRODUCT (CALKLIN OR SIMILAR) WITHOUT COOLING**
BOTÓN DE LIMPIEZA: PERMITE RECIRCULAR EL AGUA CON EL DESINCRUSTANTE (CALKLIN O SIMILAR) SIN REFRIGERACIÓN
- ▶ **EASI: EASY ACCESS FOR SERVICE & INSTALLATION. ALL PANELS CAN BE DISASSEMBLED SEPARATELY**
EASI: FÁCIL ACCESO A CUALQUIER PUNTO YA QUE TODOS LOS PANELES PUEDEN SER DESMONTADOS DE FORMA INDEPENDIENTE
- ▶ **STRONGEST DOOR OPENING SYSTEM PATENTED BY ITV. DOOR MADE IN STAINLESS STEEL AISI 304**
SISTEMA DE APERTURA MÁS ROBUSTO DEL MERCADO. PUERTA HECHA EN ACERO INOXIDABLE. SISTEMA DE APERTURA Y AMORTIGUACIÓN PATENTADO POR ITV
- ▶ **SMART FRONT VENTILATION SYSTEM (SFVS) ALLOWS BUILT-IN INSTALLATION OF THE UNIT**
EL SISTEMA INTELIGENTE DE VENTILACIÓN FRONTAL (SFVS) PERMITE LA INSTALACIÓN EMPOTRADA DE LA MÁQUINA
- ▶ **ELECTRONIC CONTROL THAT ENHANCES THE PERFORMANCE OF THE MACHINE AND ALLOWS IT TO ADAPT TO EXTREME CLIMATES**
CONTROL ELECTRÓNICO QUE MEJORA EL FUNCIONAMIENTO DE LA MÁQUINA Y LE PERMITE ADAPTARSE A CLIMAS EXTREMOS
- ▶ **NATURAL GAS R290 WITH VERY LOW GLOBAL WARMING POTENTIAL WHICH ALSO REDUCES THE ENERGY CONSUMPTION**
GAS NATURAL R290 CON MUY BAJO ÍNDICE GWP EL CUAL TAMBIÉN REDUCE EL CONSUMO ENERGÉTICO
- ▶ **LED ON/OFF SWITCH / PCB MOUNTED AT THE BOTTOM**
INTERRUPTOR LED DE FUNCIONAMIENTO ON-OFF/ PLACA ELECTRÓNICA MONTADA EN LA PARTE INFERIOR
- ▶ **TROPICALIZED MACHINES (T CLASS) / HEIGHT ADJUSTABLE LEGS FROM 105MM TO 155MM**
MÁQUINAS TROPICALIZADAS (CLASE T) / PATAS DE ALTURA AJUSTABLE DE 105MM A 155MM



	 24 H	 10°C (Kg)	 10°C (Kg)	 21°C (Kg)	 15°C (Kg)	 STOCK (Kg)	 (mm)	 (mm)
FD/HD 100 A		100	99			35	Width 660 Depth 700 Height 832*	Width 740 Depth 720 Height 955
FD/HD 100 W		-	-					

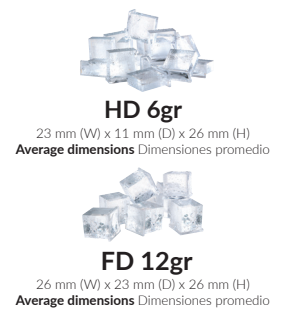

ACCESSORIES ACCESORIOS

INCLUDED



WATER INLET HOSE
MANGUERA DE ENTRADA DE AGUA



WATER OUTLET HOSE
MANGUERA DE DESAGÜE



4 HEIGHT ADJUSTABLE LEG KIT
KIT 4 PATAS ALTURA REGULABLE



WATER INLET FILTER GASKET
JUNTA DE FILTRO DE ENTRADA DE AGUA



MEDIUM SCOOP
PALA MEDIANA

NOT INCLUDED (OPTIONAL)



ANTI-LIMESCALE FILTER
FILTRO ANTICAL



PARTICLE FILTER
FILTRO ANTIPARTÍCULAS



ANTI-CHLORINE FILTER
FILTRO ANTICLORO



ANTI-LIMESCALE + ANTI-CHLORINE FILTER CS101
FILTRO ANTICAL + ANTICLORO CS101



C4 WATER SOFTENER
DESCALCIFICADOR C4



CALKLIN 50 CLEANER
PRODUCTO ANTICAL



SIDE VIEW
VISTA LATERAL

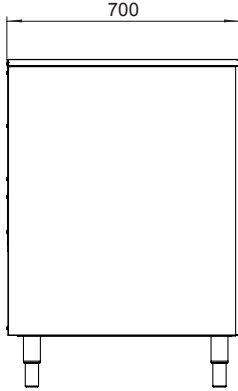

FRONTAL VIEW
VISTA FRONTAL

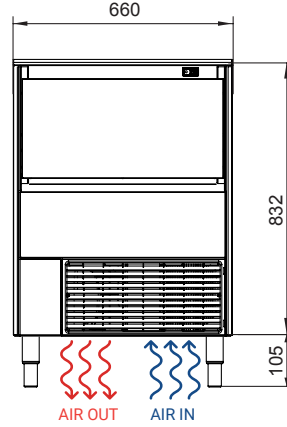

REAR VIEW
VISTA TRASERA

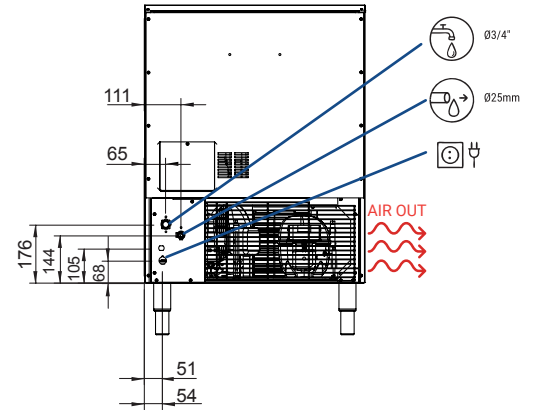

* All measurements in mm.
* Todas las cotas en mm.

OPERATING CONDITIONS CONDICIONES DE OPERACIÓN

PRODUCTION 60Hz PRODUCCIÓN 60 Hz

±10% V

10°C/43°C

5°C/38°C

1 bar/6 bar

120/240 Ice cubes/cycle

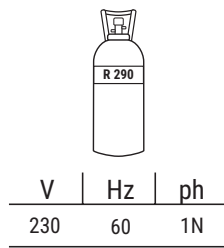

FD/HD 100 AIR COOLED

°C / °F	10° / 50°	15° / 60°	21° / 70°	30° / 86°
10° / 50°	100	100	80	75
21° / 68°	103	99	75	72
32° / 90°	94	91	73	70
43° / 109°	85	80	58	55

F/HD 100 WATER COOLED

°C / °F	10° / 50°	15° / 60°	21° / 70°	30° / 86°
10° / 50°	-	-	-	-
21° / 68°	-	-	-	-
32° / 90°	-	-	-	-
43° / 109°	-	-	-	-

MODELS
MODELOS

FD/HD 100 A

FD/HD 100 W

	ASHRAE CONDITIONS CONDICIONES ASHRAE	(W)	(BTU/h)	(W) 43°C	(n.)	(mm ²)	FUSE	100 Kg (Kwh)	(l/h) FULL HALF	HEAT REJECTED (W) (BTU/h)	(Kg)	(Kg)	(m ³)
FD/HD 100 A		1.154	3.935,1	440	3	1,5	16	8,6	6,4 6,4	836 2.850	64	76	0,51
FD/HD 100 W		-	-	-	-	-	-	-	- -	- -	-	-	-