









SC 35000 SPLIT THREE PHASE 400 V / 50-60 Hz

MODULAR FLAKE ICE MACHINE SPLIT

FEATURES CARATTERISTICHE

- ▶ **PRODUCES COLD AND DRY FLAT FLAKES. FLAKE THICKNESS MAY BE ADJUSTED BETWEEN 1.5 mm AND 3 mm.**
PRODUCE SCAGLIE PIANE MOLTO FREDDI E ASCIUTTE. LO SPESSORE È REGOLABILE DA 1.5 A 3 mm.
- ▶ **BASED ON A STATIC CYLINDER WHICH IS FREE FROM SWIVEL JOINTS (HELICAL REAMER) COUPLED WITH A MILLING TOOL THAT DETACHES THE ICE WITHOUT ANY STRAINED OR FORCED MOVEMENTS.**
FUNZIONAMENTO BASATO SU UN CILINDRO STATICO SENZA GIUNTI ROTANTI (ALESATORE ELICOIDALE) E CON UNA FRESA CHE STACCA IL GHIACCIO SENZA TENSIONE O SFORZO.
- ▶ **THE MOST EFFICIENT EVAPORATOR OF THE MARKET, LESS ENERGY CONSUMPTION AND HIGHER ICE PRODUCTION.**
L'EVAPORATORE PIÙ EFFICIENTE SUL MERCATO, CONSUMO ENERGETICO MINORE, MAGGIORE PRODUZIONE DI GHIACCIO.
- ▶ **ELECTRONIC STOP SYSTEM / ELECTRICAL CONTROL PANEL / DRIVE DIRECT GEAR MOTOR / MAGNETIC DRIVE PUMP / LOW WATER SAFETY DEVICE.**
SISTEMA ELETTRONICO DI ARRESTO / PANNELLO DI CONTROLLO ELETTRICO / MOTORIDUTTORE CON TRASMISSIONE DIRETTA / POMPA A TRASCINAMENTO MAGNETICO / DISPOSITIVO DI SICUREZZA IN CASO DI MANCANZA DI ACQUA.
- ▶ **STAINLESS STEEL SOLEPLATE.**
PIASTRA IN ACCIAIO INOSSIDABILE.
- ▶ **CONTROLLERS TO DETECT: LOW WATER LEVEL, TEMPERATURE RISE DUE TO MOTOR OVERLOAD OR FULL VAT.**
DISPOSITIVI PER RILEVARE: MANCANZA DI ACQUA, AUMENTO DELLA TEMPERATURA A CAUSA DEL SOVRACCARICO DEL MOTORE O PER RIEMPIMENTO DELLA VASCHETTA.
- ▶ **ELECTRONIC EXPANSION VALVE / SUCTION REGULATING VALVE / STOP WHEN FULL BIN STOP WITH PHOTOELECTRICAL SENSOR.**
VALVOLA AD ESPANSIONE ELETTRONICA / VALVOLA DI REGOLAZIONE DELL'ASPIRAZIONE / ARRESTO PER RIEMPIMENTO DELLA VASCHETTA CON CELLULA FOTOELETTRICA.



	 24 H	 10°C (Kg)  10°C	 21°C (Kg)  15°C	 (mm)	 (mm)	
SC 35000 SPLIT 		38.500	35.000	Width 2.135 Depth 3.100 Height 2.700	Width - Depth - Height -	FLAKE ICE -7°C Ice Temperature

ACCESSORIES ACCESSORI

NOT INCLUDED (OPTIONAL)



SALT DOSING PUMP WITH TANK
BOMBA DOSATORE DI SALE CON
SERBATOIO



REMOTE SWITCH
INTERRUTTORE REMOTO



REMOTE SWITCH & WEEKLY PROGRAMMER
INTERRUTTORE REMOTO CON TIMER SETTIMANALE



EXTERNAL STOP FULL BIN PHOTO CELL
SENSORE DI ARRESTO ESTERNO PER
RIEMPIMENTO

RECOMMENDED BINS SERBATOI RACCOMANDATI



BS422 + SC 35000 SPLIT



BS623 + SC 35000 SPLIT



BS732 + SC 35000 SPLIT



BS1132 + SC 35000 SPLIT

SC 35000 SPLIT

RIGHT SIDE VIEW
VISTA LATERALE DESTRA

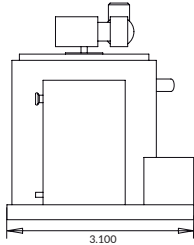

FRONTAL VIEW
VISTA FRONTALE

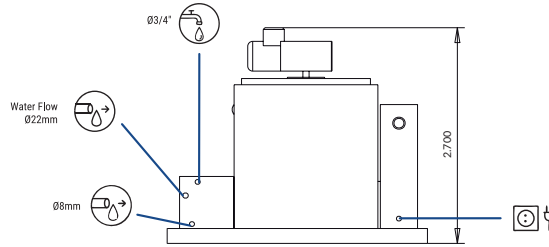

LEFT SIDE VIEW
VISTA LATERALE SINISTRO

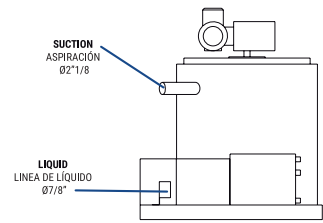

CENTRAL CROSS SECTION VIEW OF THE BASE
VISTA DELLA BASE DALLA ZONA CENTRALE

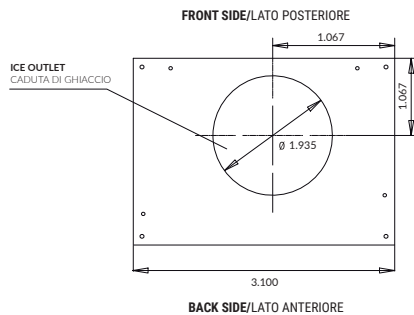

* All measurements in mm.
* Tutte le misure in mm.

OPERATING CONDITIONS CONDIZIONI PER IL FUNZIONAMENTO

PRODUCTION 50-60Hz PRODUZIONE 50-60 Hz

Icon	Value	SC 35000 SPLIT					SC 35000 SPLIT				
		10°	15°	21°	30°	10°	15°	21°	30°		
±10% V											
10°C/43°C		38500	36500	31500	29000	35805	33945	29295	26970		
5°C/38°C		38100	35000	30000	27500	35433	32550	27900	25575		
1 bar/6 bar		36000	32500	28000	25200	33480	30225	26040	23436		
		30500	27500	23000	21000	28365	25575	21390	19530		

MODELS MODELLI	Temp.EV. (°C)	ASHRAE CONDITIONS CONDIZIONI ASHRAE (W) (BTu/h)	(W) 43°C	(n.) (mm²)	FUSE	100 Kg (Kw/h)	(l/h)	HEAT REJECTED (W) (BTu/h)	(Kg)	(Kg)	(m³)
SC 35000 S		192.500 656.837	1.170	5 1,5	16	-*	1.458	- -	4.800	-	-

* WHEN INDICATED COOL REQUIREMENT IS SUPPLIED / QUANDO VIENE FORNITA LA POTENZA FRIGORIFERA RICHIESTA.

0000_ict/emt_21/E/21



ICETECH, S.A.
POL. IND. LA REVA, SECTOR 13, AV. GREMIS, 1
46394 RIBARROJA DE TURIA, VALENCIA, SPAIN
PHONE: +34 961 667 636 FAX: +34 961 668 944
sales@icetechice.com | www.icetechice.com



SERVICE
SERVIZIO ASSISTENZA TECNICA
sales@icetechice.com
Skype: ICETECH.Service
+34 961 667 639
8:00AM | 7:00PM



Subject to certain limitations and exclusions. Only spare parts.
Soggetta a limitazioni e revoca. Solo parti di ricambio.



9001
14001

