

SC 50000 R717 SPLIT THREE PHASE 400 V / 50-60 Hz

MODULAR FLAKE ICE MACHINE SPLIT

FEATURES CARATTERISTICHE

▶ **PRODUCES COLD AND DRY FLAT FLAKES. FLAKE THICKNESS MAY BE ADJUSTED BETWEEN 1.5 mm AND 3 mm.**
 PRODUCE SCAGLIE PIANE MOLTO FREDDI E ASCIUTTE. LO SPESSORE È REGOLABILE DA 1.5 A 3 mm.

▶ **BASED ON A STATIC CYLINDER WHICH IS FREE FROM SWIVEL JOINTS (HELICAL REAMER) COUPLED WITH A MILLING TOOL THAT DETACHES THE ICE WITHOUT ANY STRAINED OR FORCED MOVEMENTS.**
 FUNZIONAMENTO BASATO SU UN CILINDRO STATICO SENZA GIUNTI ROTANTI (ALESATORE ELICOIDALE) E CON UNA FRESA CHE STACCA IL GHIACCIO SENZA TENSIONE O SFORZO.

▶ **THE MOST EFFICIENT EVAPORATOR OF THE MARKET, LESS ENERGY CONSUMPTION AND HIGHER ICE PRODUCTION.**
 L'EVAPORATORE PIÙ EFFICIENTE SUL MERCATO, CONSUMO ENERGETICO MINORE, MAGGIORE PRODUZIONE DI GHIACCIO.

▶ **LIQUID SOLENOID VALVE / FULL BIN STOP WITH PHOTOELECTRICAL SENSOR.**
 VALVOLA A SOLENOIDE DEL LIQUIDO / ARRESTO PER RIEMPIMENTO DELLA CISTERNA CON SENSORE FOTOELETTRICO.







▶ **ELECTRONIC STOP SYSTEM / ELECTRICAL CONTROL PANEL / DRIVE DIRECT GEAR MOTOR / MAGNETIC DRIVE PUMP / LOW WATER SAFETY DEVICE.**
 SISTEMA ELETTRONICO DI ARRESTO / PANNELLO DI CONTROLLO ELETTRICO / MOTORIDUTTORE CON TRASMISSIONE DIRETTA / POMPA A TRASCINAMENTO MAGNETICO / DISPOSITIVO DI SICUREZZA IN CASO DI MANCANZA DI ACQUA.

▶ **STAINLESS STEEL SOLEPLATE.**
 PIASTRA IN ACCIAIO INOSSIDABILE.

▶ **CONTROLLERS TO DETECT: LOW WATER LEVEL, TEMPERATURE RISE DUE TO MOTOR OVERLOAD OR FULL VAT.**
 DISPOSITIVI PER RILEVARE: MANCANZA DI ACQUA, AUMENTO DELLA TEMPERATURA A CAUSA DEL SOVRACCARICO DEL MOTORE O PER RIEMPIMENTO DELLA VASCHETTA.

▶ **AN EXTERNAL PUMP IS REQUIRED (NOT INCLUDED), IN ORDER TO CIRCULATE THE AMMONIA ALONG THE REFRIGERATION SYSTEM. EXPANSION VALVE FREE SYSTEM.**
 È NECESSARIA UNA POMPA ESTERNA (NON INCLUSO) PER IL RICIRCOLO DELL'AMMONIACA NEL SISTEMA DI REFRIGERAZIONE. SISTEMA PRIVO DI VALVOLA DI ESPANSIONE.



| |  24 H |  10°C |  15°C |  21°C |  |  |  |
|------------------------|--|--|--|--|---|---|---|
| | (Kg) | (Kg) | (Kg) | (Kg) | (mm) | (mm) | FLAKE ICE -7°C Ice Temperature |
| SC 50000 R717 SPLIT | 55.000 | 50.000 | Width 2.135 Depth 3.100 Height 3.300 | Width 2.235 Depth 3.200 Height 3.555 | | | |

ACCESSORIES ACCESSORI

NOT INCLUDED (OPTIONAL)



REMOTE SWITCH
INTERRUTTORE REMOTO



REMOTE SWITCH & WEEKLY PROGRAMMER
INTERRUTTORE REMOTO CON TIMER SETTIMANALE



EXTERNAL STOP FULL BIN PHOTO CELL
SENSORE DI ARRESTO ESTERNO PER RIEMPIMENTO

RECOMMENDED BINS SERBATOI RACCOMANDATI



BS422 + SC 50000 SPLIT



BS623 + SC 50000 SPLIT



BS732 + SC 50000 SPLIT



BS1132 + SC 50000 SPLIT

SC 50000 R717 SPLIT

RIGHT SIDE VIEW
VISTA LATERALE DESTRA

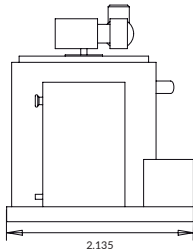

FRONTAL VIEW
VISTA FRONTALE

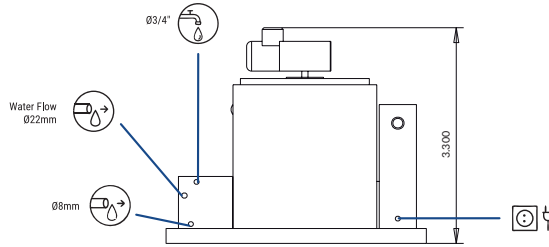

LEFT SIDE VIEW
VISTA LATERALE SINISTRA

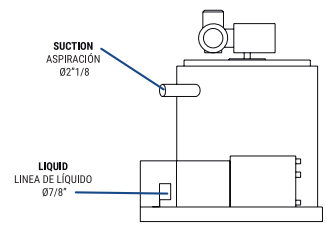

CENTRAL CROSS SECTION VIEW OF THE BASE
VISTA DELLA BASE DALLA ZONA CENTRALE

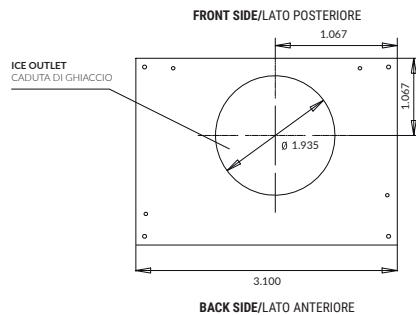

* All measurements in mm.
* Tutte le misure in mm.

OPERATING CONDITIONS CONDIZIONI PER IL FUNZIONAMENTO

PRODUCTION 50-60Hz PRODUZIONE 50-60 Hz

- ±10% V
- 10°C/43°C
- 5°C/38°C
- 1 bar/6 bar

| |
|------------------|
| |
| V Hz ph |
| 400 50-60 3N |

| | | |
|------|----------------------------|---------------------|
| 24 H | 1'5-2'2 mm | SC 50000 R717 SPLIT |
| | °C 10° 15° 21° 30° | |
| | °F 50° 60° 70° 86° | |
| | 10° | 55000 |
| | 50° | 52143 |
| | 21° | 45000 |
| | 68° | 41429 |
| | 21° | 54429 |
| | 68° | 50000 |
| | 21° | 42857 |
| | 68° | 39286 |
| | 32° | 51429 |
| | 90° | 46429 |
| | 90° | 40000 |
| | 90° | 36000 |
| | 43° | 43571 |
| | 109° | 39286 |
| | 109° | 32857 |
| | 109° | 30000 |

| | | |
|------|----------------------------|---------------------|
| 24 H | 3 mm | SC 50000 R717 SPLIT |
| | °C 10° 15° 21° 30° | |
| | °F 50° 60° 70° 86° | |
| | 10° | 51150 |
| | 50° | 48493 |
| | 21° | 41850 |
| | 68° | 39529 |
| | 21° | 50619 |
| | 68° | 46500 |
| | 21° | 39857 |
| | 68° | 36536 |
| | 32° | 47829 |
| | 90° | 43179 |
| | 90° | 37200 |
| | 90° | 33480 |
| | 43° | 40521 |
| | 109° | 36536 |
| | 109° | 30557 |
| | 109° | 27900 |

| MODELS MODELLI | Temp.EV. (°C) | ASHRAE CONDITIONS CONDIZIONI ASHRAE (W) (BTU/h) | Refrig. liquid (l/h) | (n.) (mm ²) | FUSE | 100 Kg (Kwh) | (l/h) | HEAT REJECTED (W) (BTU/h) | (Kg) | (Kg) (m ³) |
|------------------------|------------------|---|-------------------------|-------------------------|------|-----------------|-------|------------------------------|-------|------------------------|
| SC 50000 R717 SPLIT | -22 | 275.000 938.339 | 1.170 | 6.000 | 5 | 1,5 | 16 | -* | 2.083 | - - 5.025 5.125 25,4 |

* WHEN INDICATED COOL REQUIREMENT IS SUPPLIED / QUANDO VIENE FORNITA LA POTENZA FRIGORIFERA RICHIESTA.