



BCD400















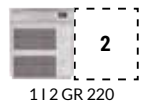

ICE BIN WITH CART FOR MODULAR MACHINES

FEATURES CARACTERÍSTICAS

- ▶ **ICE BIN CAPACITY OF 413 KG (CART CAPACITY NOT INCLUDED).**
DEPÓSITO PARA HIELO CON CAPACIDAD DE 413 KG (CAPACIDAD DE LOS CARROS NO INCLUIDA).
- ▶ **AISI 304 STAINLESS STEEL BIN.**
DEPÓSITO DE ACERO INOXIDABLE CALIDAD AISI 304.
- ▶ **HARD SANITARY POLYETHYLENE VAT, RESISTANT TO BLOWS, AND SCRATCHES.**
CUBA INTERIOR DE POLIETILENO SANITARIO DE GRAN DUREZA, RESISTENTE A GOLPES, Y ROCES.
- ▶ **EASY CLEANING DESIGN®: SEAMLESS ONE-PIECE VAT WITH ROUNDED CORNERS, AVOIDING POSSIBLE DIRTY POINTS AND FACILITATING CLEANING.**
EASY CLEANING DESIGN®: CUBA INTERIOR SIN JUNTAS, DE UNA SOLA PIEZA, CON ESQUINAS REDONDEADAS, ELIMINANDO POSIBLES PUNTOS DE SUCIEDAD Y FACILITANDO LA LIMPIEZA.
- ▶ **DRAINAGE SYSTEM THAT COLLECTS AND DRIVES THE WATER TO THE DRAIN KEEPING THE BIN AND FLOOR CLEAN & DRY.**
SISTEMA DE DRENAJE QUE RECOGE Y CONDUCE EL AGUA AL DESAGÜE MANTENIENDO TANTO EL SILO Y COMO SUELO LIMPIOS Y SECOS.
- ▶ **LARGE CAPACITY EASY CART®, UP TO 112 KG OF ICE (70 KG WITH BUCKETS); ERGONOMIC, EASY TO MOVE WITH LITTLE EFFORT.**
EASY CART® DE GRAN CAPACIDAD, HASTA 112 KG DE HIELO (70 KG CON CESTAS) Y ERGONÓMICOS, FÁCILES DE MOVER SIN APENAS ESFUERZO.
- ▶ **EASY CART® HAS A BRAKING AND DRAINAGE SYSTEM.**
EASY CART® DISPONE DE SISTEMA DE FRENADO Y DESAGÜE.
- ▶ **EASY CART® IS MADE OF SANITARY POLYETHYLENE, WITH SMOOTH SURFACE TO FACILITATE CLEANING. IT INCLUDES A COVER TO PREVENT DIRT FROM CONTAMINATING THE ICE.**
EASY CART® EN POLIETILENO SANITARIO, SIN RUGOSIDADES PARA FACILITAR LA LIMPIEZA. INCLUYE TAPA PARA QUE EL POLVO NO CONTAMINE EL HIELO.
- ▶ **BUCKETS FOR DISTRIBUTING ICE QUICKLY AND EFFORTLESSLY CAN BE INCLUDED.**
SE PUEDEN INCLUIR CESTAS PARA REPARTIR EL HIELO RÁPIDAMENTE Y SIN ESFUERZO.



RECOMMENDED MACHINES MÁQUINAS RECOMENDADAS

SS/SK	FD/HD	PS	GR	SC
 RECOMMENDED RECOMENDADO  2 SS150 SS400	 112 FD/HD 215  112 FD/HD 415  FD/HD 315 SLIM		 112 GR 220  112 GR 400  112 GR 560 SPLIT  GR 560 GR 850 CO2 SPLIT  GR 1100 GR 1100 SPLIT	 SC 400  SC 600  SC 1TN / SC 1.5TN / SC 2TN / SC 3TN SPLIT
 NOT RECOMMENDED NO RECOMENDADO 15%  SS150			 2 GR 560 SPLIT 2 GR 850 CO2 SPLIT	 SC 1TN

BCD 400

RIGHT SIDE VIEW
VISTA LATERAL DERECHA

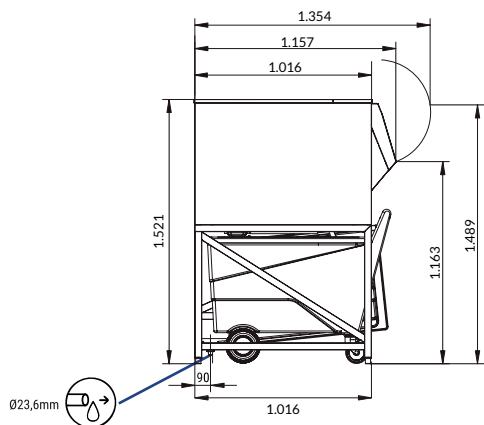

FRONTAL VIEW
VISTA FRONTAL

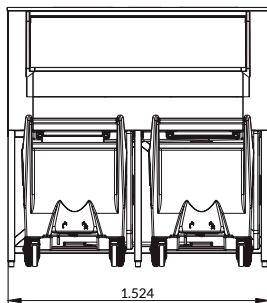

REAR VIEW
VISTA TRASERA

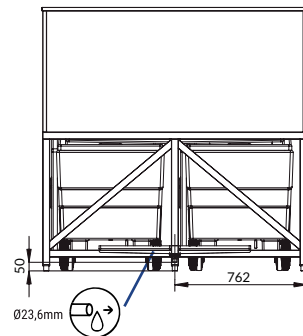

UPPER VIEW
VISTA SUPERIOR

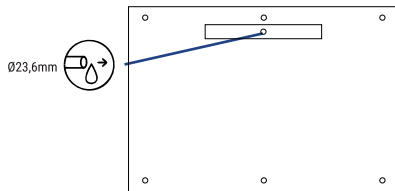

*All measurements in mm.
*Todas las cotas en mm.

ACCESSORIES ACCESORIOS

INCLUDED



WATER OUTLET HOSE
MANGUERA DE DESAGÜE



LARGE SCOOP
PALA GRANDE



ICE PADDLE
PALA DE MANGO LARGO



ICE PADDLE SUPPORT
SOPORTE PARA PALA

NOT INCLUDED (OPTIONAL)



BUCKETS
CESTAS

	(Kg)	(Kg)	(Kg)	(mm)	(Kg)	(mm)	(Kg)	(m³)
BCD 400	413	330	637	Width 1.524 Depth 1.016* Height 1.520	140	Width 1.630 Depth 1.240 Height 1.660	235	3,36

*WITHOUT DOOR SIN PUERTA