



# BCD800



















ICE BIN WITH CART FOR MODULAR MACHINES

## FEATURES CARATTERISTICHE

- ▶ **ICE BIN CAPACITY OF 812 KG (CART CAPACITY NOT INCLUDED).**  
SERBATOIO PER GHIACCIO CON CAPACITÀ DI 812 KG (CAPACITÀ DEL CARRELLO NON INCLUSA).
- ▶ **AISI 304 STAINLESS STEEL BIN.**  
SERBATOIO DI ACCIAIO INOSSIDABILE QUALITÀ AISI 304.
- ▶ **HARD SANITARY POLYETHYLENE VAT, RESISTANT TO BLOWS, AND SCRATCHES.**  
CISTERNA INTERNA DI POLIETILENE SANITARIO DI ELEVATA DUREZZA, RESISTENTE AD URTI E ATTRITI.
- ▶ **EASY CLEANING DESIGN®: SEAMLESS ONE-PIECE VAT WITH ROUNDED CORNERS, AVOIDING POSSIBLE DIRTY POINTS AND FACILITATING CLEANING.**  
EASY CLEANING DESIGN®: CISTERNA INTERNA SENZA GIUNZIONI, IN UN UNICO PEZZO, CON ANGOLI ARROTONDATI PER ELIMINARE EVENTUALI PUNTI DI SPORCIZIA E FACILITARE LA PULIZIA.
- ▶ **DRAINAGE SYSTEM THAT COLLECTS AND DRIVES THE WATER TO THE DRAIN KEEPING THE BIN AND FLOOR CLEAN & DRY.**  
SISTEMA DI DRENAGGIO CHE RACCOGLIE E CONDUCE L'ACQUA ALLO SCARICO MANTENENDO IL SERBATOIO E IL PAVIMENTO PULITI E ASCIUTTI.
- ▶ **LARGE CAPACITY EASY CART®, UP TO 112 KG OF ICE (70 KG WITH BUCKETS); ERGONOMIC, EASY TO MOVE WITH LITTLE EFFORT.**  
EASY CART® CON ELEVATA CAPACITÀ, FINO A 112 KG DI GHIACCIO (70 KG CON CESTELLI) ED ERGONOMICO, FACILE DA SPOSTARE CON IL MINIMO SFORZO.
- ▶ **EASY CART® HAS A BRAKING AND DRAINAGE SYSTEM.**  
EASY CART® DISPONE DI SISTEMA FRENANTE E SCARICO.
- ▶ **EASY CART® IS MADE OF SANITARY POLYETHYLENE, WITH SMOOTH SURFACE TO FACILITATE CLEANING. IT INCLUDES A COVER TO PREVENT DIRT FROM CONTAMINATING THE ICE.**  
EASY CART® IN POLIETILENE SANITARIO, SENZA RUGOSITÀ PER FACILITARE LA PULIZIA. INCLUDE COPERCHIO PER EVITARE CHE LA POLVERE CONTAMINI IL GHIACCIO.
- ▶ **BUCKETS FOR DISTRIBUTING ICE QUICKLY AND EFFORTLESSLY CAN BE INCLUDED.**  
SI POSSONO INCLUDERE CESTELLI PER DISTRIBUIRE IL GHIACCIO RAPIDAMENTE E SENZA SFORZO.

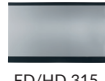

## RECOMMENDED MACHINES MACCHINE RACCOMANDATI

	SS/SK	FD/HD	PS	GR	SC
<b>RECOMMENDED RACCOMANDATO</b>	 2 SS400	 2 FD/HD 215   2 FD/HD 415		 1   2 GR 400  1   2 GR 560  1   2 GR 560 SPLIT  1   2 GR 850 CO2 SPLIT  GR 1100  GR 1100 SPLIT	 SC 400  SC 600  SC 1TN / SC 1,5TN / SC 2TN / SC 3TN SPLIT
<b>NOT RECOMMENDED NO RACCOMANDATO</b>	 15% 2 1   2 SS 150	 FD/HD 215  FD/HD 415   FD/HD 315 SLIM		 1   2 GR 220   2 GR 1100 SPLIT	 SC 1T



BCD 800

**RIGHT SIDE VIEW**  
VISTA LATERALE DESTRA

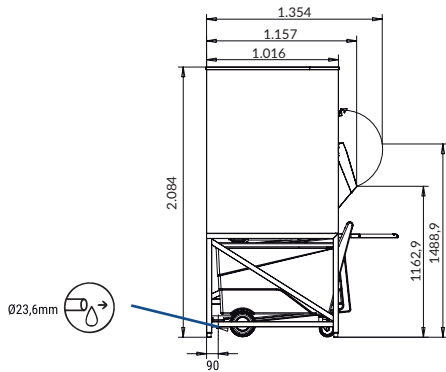

**FRONTAL VIEW**  
VISTA FRONTALE

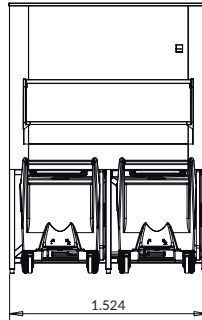

**REAR VIEW**  
VISTA POSTERIORE

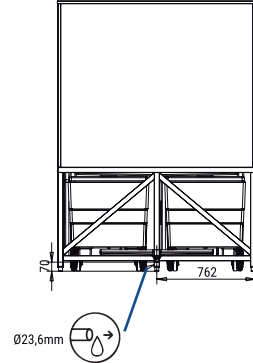

**UPPER VIEW**  
VISTA SUPERIOR

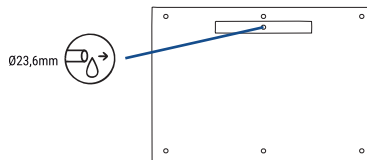

\*All measurements in mm.  
\*Tutte le misure in mm.

## ACCESSORIES ACCESSORI

### INCLOSO



**WATER OUTLET HOSE**  
TUBO DI SCARICO



**LARGE SCOOP**  
PALA GRANDE



**ICE PADDLE**  
PALA CON MANICO LUNGO











**ICE PADDLE SUPPORT**  
SUPPORTO PER LA PALA

### NON INCLUSO (OPTIONAL)



**BUCKETS**  
CESTELLI

	 (Kg)	 (Kg)	 (Kg)	 (mm)	 (Kg)	 (mm)	 (Kg)	 (m <sup>3</sup> )
BCD 800	812	650	1.036	Width 1.524 Depth 1.016 Height 2.084	175	Width 1.630 Depth 1.240 Height 2.240	276	4,53

\*Without door nessuna porta