



# BCS 150











ICE BIN WITH CART FOR MODULAR MACHINES

## FEATURES CARACTERÍSTICAS

- ▶ **ICE BIN CAPACITY OF 140 KG (CART CAPACITY NOT INCLUDED).**  
DEPÓSITO PARA HIELO CON CAPACIDAD DE 140 KG (CAPACIDAD DEL CARRO NO INCLUIDA).
- ▶ **AISI 304 STAINLESS STEEL BIN.**  
DEPÓSITO DE ACERO INOXIDABLE CALIDAD AISI 304.
- ▶ **HARD SANITARY POLYETHYLENE VAT, RESISTANT TO BLOWS, AND SCRATCHES.**  
CUBA INTERIOR DE POLIETILENO SANITARIO DE GRAN DUREZA, RESISTENTE A GOLPES, Y ROCES.
- ▶ **EASY CLEANING DESIGN®: SEAMLESS ONE-PIECE VAT WITH ROUNDED CORNERS, AVOIDING POSSIBLE DIRTY POINTS AND FACILITATING CLEANING.**  
EASY CLEANING DESIGN®: CUBA INTERIOR SIN JUNTAS, DE UNA SOLA PIEZA, CON ESQUINAS REDONDEADAS, ELIMINANDO POSIBLES PUNTOS DE SUCIEDAD Y FACILITANDO LA LIMPIEZA.
- ▶ **DRAINAGE SYSTEM THAT COLLECTS AND DRIVES THE WATER TO THE DRAIN KEEPING THE BIN AND FLOOR CLEAN & DRY.**  
SISTEMA DE DRENAJE QUE RECOGE Y CONDUCE EL AGUA AL DESAGÜE MANTENIENDO TANTO EL SILO Y COMO SUELO LIMPIOS Y SECOS.
- ▶ **LARGE CAPACITY EASY CART®, UP TO 112 KG OF ICE (70 KG WITH BUCKETS); ERGONOMIC, EASY TO MOVE WITH LITTLE EFFORT.**  
EASY CART® DE GRAN CAPACIDAD, HASTA 112 KG DE HIELO (70 KG CON CESTAS) Y ERGONÓMICO, FÁCIL DE MOVER SIN APENAS ESFUERZO.
- ▶ **EASY CART® HAS A BRAKING AND DRAINAGE SYSTEM.**  
EASY CART® DISPONE DE SISTEMA DE FRENADO Y DESAGÜE.
- ▶ **EASY CART® IS MADE OF SANITARY POLYETHYLENE, WITH SMOOTH SURFACE TO FACILITATE CLEANING. IT INCLUDES A COVER TO PREVENT DIRT FROM CONTAMINATING THE ICE.**  
EASY CART® EN POLIETILENO SANITARIO, SIN RUGOSIDADES PARA FACILITAR LA LIMPIEZA. INCLUYE TAPA PARA QUE EL POLVO NO CONTAMINE EL HIELO.
- ▶ **BUCKETS FOR DISTRIBUTING ICE QUICKLY AND EFFORTLESSLY CAN BE INCLUDED.**  
SE PUEDEN INCLUIR CESTAS PARA REPARTIR EL HIELO RÁPIDAMENTE Y SIN ESFUERZO.

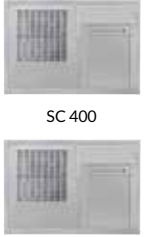

## RECOMMENDED MACHINES MÁQUINAS RECOMENDADAS

	SS/SK	FD/HD	PS	GR	SC
 <b>RECOMMENDED</b> RECOMENDADO	 2 SS150	 FD/HD 215 FD/HD 315 SLIM		 GR 220    GR 400    GR 560	
		 2 112 FD/HD 415		 GR 560 SPLIT    GR 850 CO2 SPLIT    GR 1100 SPLIT	
 <b>NOT RECOMMENDED</b> NO RECOMENDADO	 15% SS 150	 FD/HD 215		 2 2 GR 560 SPLIT 2 2 GR 850 CO2 SPLIT	 SC 400 SC 600



BCS 150

RIGHT SIDE VIEW  
VISTA LATERAL DERECHA

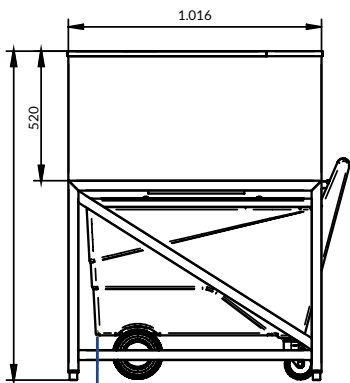

FRONTAL VIEW  
VISTA FRONTAL

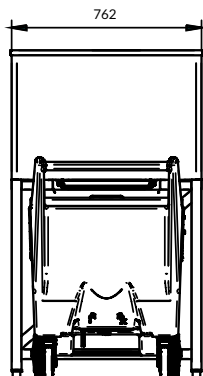

REAR VIEW  
VISTA TRASERA

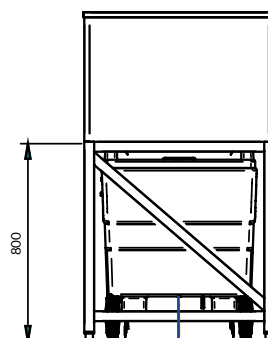

UPPER VIEW  
VISTA SUPERIOR

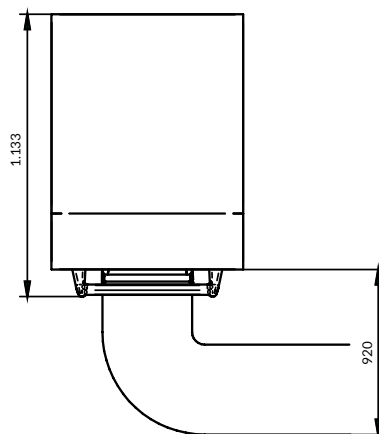

\*All measurements in mm.  
\*Todas las cotas en mm.

ACCESSORIES ACCESORIOS

INCLUDED



WATER OUTLET HOSE  
MANGUERA DE DESAGÜE



ICE PADDLE  
PALA DE MANGO LARGO



ICE PADDLE SUPPORT  
SOPORTE PARA PALA

NOT INCLUDED (OPTIONAL)



BUCKETS  
CESTAS



(Kg)



(Kg)



(Kg)



(mm)



(Kg)



(mm)



(Kg)

(m³)

BCS 150

140

110

252

Width 762  
Depth 1.016  
Height 1.320

75

Width 962  
Depth 1.216  
Height 1.520

82

1,78



ICETECH, S.A.  
POL. IND. LA REVA, SECTOR 13, AV. GREMIS, 1  
46394 RIBARROJA DE TURIA, VALENCIA, SPAIN  
PHONE: +34 961 667 636 | FAX: +34 961 668 944  
sales@icetechice.com | www.icetechice.com



SERVICE  
SERVICIO ASISTENCIA TÉCNICA  
service@icetechice.com  
Skype: ICETECH.Service  
+34 961 667 639  
8:00AM | 7:00PM



Subject to certain limitations  
and exclusions. Only spare parts.  
Sujeto a limitaciones y exclusiones.  
Solo piezas de repuesto.



9001  
14001



tecno  
CERT