



# B 135













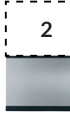

ICE BIN FOR MODULAR MACHINES

## FEATURES CARATTERISTICHE

- ▶ **ICE BIN CAPACITY OF 160 KG.**  
SERBATOIO PER GHIACCIO CON CAPACITÀ DI 160 KG.
- ▶ **AISI 304 STAINLESS STEEL BINS.**  
SERBATOIO DI ACCIAIO INOSSIDABILE QUALITÀ AISI 304.
- ▶ **VERY HARD SANITARY POLYETHYLENE VAT, RESISTANT TO BLOWS, AND SCRATCHES.**  
CISTERNA INTERNA DI POLIETILENE SANITARIO DI ELEVATA DUREZZA, RESISTENTE AD URTI E ATTRITI.
- ▶ **EASY CLEANING DESIGN®: SEAMLESS ONE-PIECE VAT WITH ROUNDED CORNERS, AVOIDING POSSIBLE DIRTY POINTS AND FACILITATING CLEANING.**  
EASY CLEANING DESIGN®: CISTERNA INTERNA SENZA GIUNZIONI, IN UN UNICO PEZZO, CON ANGOLI ARROTONDATI PER ELIMINARE EVENTUALI PUNTI DI SPORCIZIA E FACILITARE LA PULIZIA.
- ▶ **DRAINAGE SYSTEM THAT COLLECTS AND DRIVES THE WATER TO THE DRAIN KEEPING THE BIN CLEAN & DRY.**  
SISTEMA DI DRENAGGIO CHE RACCOGLIE E CONDUCE L'ACQUA ALLO SCARICO MANTENENDO IL SERBATOIO E IL PAVIMENTO PULITI E ASCIUTTI.



## RECOMMENDED MACHINES MACCHINE RACCOMANDATI

SS/SK	FD/HD	PS	GR	SC
  RECOMMENDED RACCOMANDATO	 1 1 2 SS150	 1 1 2 FD/HD 215	 GR 140	 GR 220
	 FD/HD 315 SLIM		 GR 400	 GR 560
	 1 1 2 FD/HD 415		 GR 560 SPLIT	 GR 850 CO2 SPLIT
  NOT RECOMMENDED NO RACCOMANDATO	 1 1 2 FD/HD 415		 GR1100 SPLIT	



B 135

RIGHT SIDE VIEW  
VISTA LATERALE SINISTRA

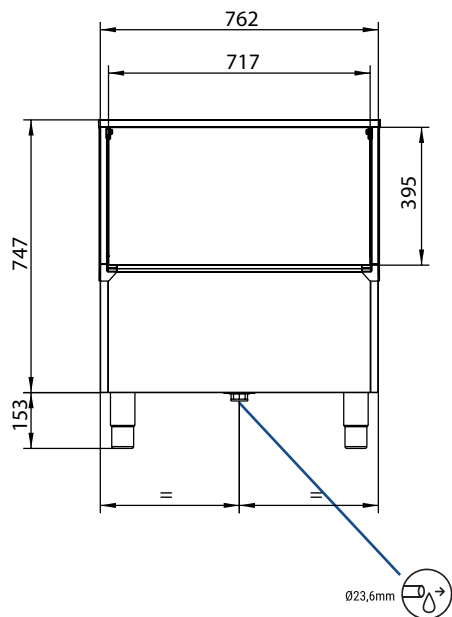

FRONTAL VIEW  
VISTA FRONTALE

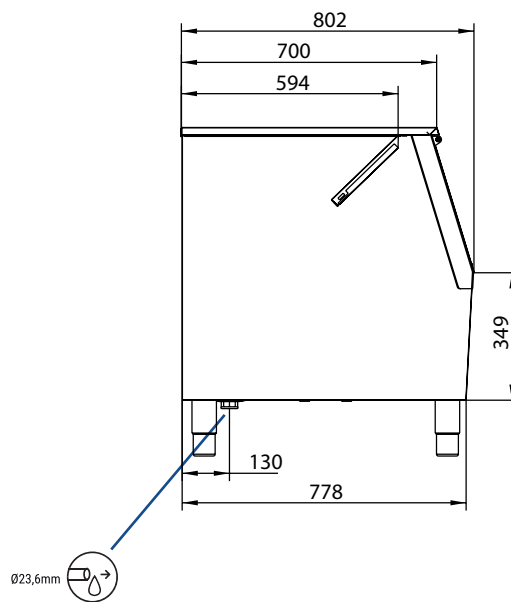

\*All measurements in mm.  
\*Tutte le misure in mm.

ACCESSORIES ACCESSORI

INCLUSO



4 HEIGHT ADJUSTABLE  
LEG KIT  
KIT 4 PIEDINI ALTEZZA  
REGOLABILE



LARGE SCOOP  
PALA GRANDE



WATER OUTLET HOSE  
TUBO DI SCARICO



DRAINAGE ELBOW  
CURVA DI SCARICO



(m<sup>3</sup>)

B 135

160

128

Width 762  
Depth 819  
Height\* 740

52

Width 850  
Depth 890  
Height\* 870

53

0,59

\*900 mm with legs  
\*900 mm con piedini



ICETECH, S.A.  
POL. IND. LA REVA, SECTOR 13, AV. GREMIS, 1  
46394 RIBARROJA DE TURIA, VALENCIA, SPAIN  
PHONE: +34 961 667 636 | FAX: +34 961 668 944  
sales@icetechice.com | www.icetechice.com



SERVICE  
SERVIZIO ASSISTENZA TECNICA  
sales@icetechice.com  
Skype: ICETECH.Service  
+34 961 667 639  
8:00AM | 7:00PM



Subject to certain limitations  
and exclusions. Only spare parts.  
Soggetta a limitazioni e revoca.  
Solo parti di ricambio.

