



B 210













ICE BIN FOR MODULAR MACHINES

FEATURES CARATTERISTICHE

- ▶ **ICE BIN CAPACITY OF 225 KG.**
SERBATOIO PER GHIACCIO CON CAPACITÀ DI 225 KG.
- ▶ **AISI 304 STAINLESS STEEL BINS.**
SERBATOIO DI ACCIAIO INOSSIDABILE QUALITÀ AISI 304.
- ▶ **VERY HARD SANITARY POLYETHYLENE VAT, RESISTANT TO BLOWS, AND SCRATCHES.**
CISTERNA INTERNA DI POLIETILENE SANITARIO DI ELEVATA DUREZZA, RESISTENTE AD URTI E ATTRITI.
- ▶ **EASY CLEANING DESIGN®: SEAMLESS ONE-PIECE VAT WITH ROUNDED CORNERS, AVOIDING POSSIBLE DIRTY POINTS AND FACILITATING CLEANING.**
EASY CLEANING DESIGN®: CISTERNA INTERNA SENZA GIUNZIONI, IN UN UNICO PEZZO, CON ANGOLI ARROTONDATI PER ELIMINARE EVENTUALI PUNTI DI SPORCIZIA E FACILITARE LA PULIZIA.
- ▶ **DRAINAGE SYSTEM THAT COLLECTS AND DRIVES THE WATER TO THE DRAIN KEEPING THE BIN CLEAN & DRY.**
SISTEMA DI DRENAGGIO CHE RACCOGLIE E CONDUCE L'ACQUA ALLO SCARICO MANTENENDO IL SERBATOIO E IL PAVIMENTO PULITI E ASCIUTTI.



RECOMMENDED MACHINES MACCHINE RACCOMANDATI

	SS/SK	FD/HD	PS	GR	SC
 RECOMMENDED RACCOMANDATO	 112 SS150	 112 FD/HD 215		 GR 220	
		 FD/HD 315 SLIM		 GR 400	 GR 560
		 112 FD/HD 415		 GR 560 SPLIT	 GR 850 CO2 SPLIT
 NOT RECOMMENDED NO RACCOMANDATO				 GR1100 SPLIT	

B 210

RIGHT SIDE VIEW
VISTA LATERALE DESTRA

FRONTAL VIEW
VISTA FRONTALE

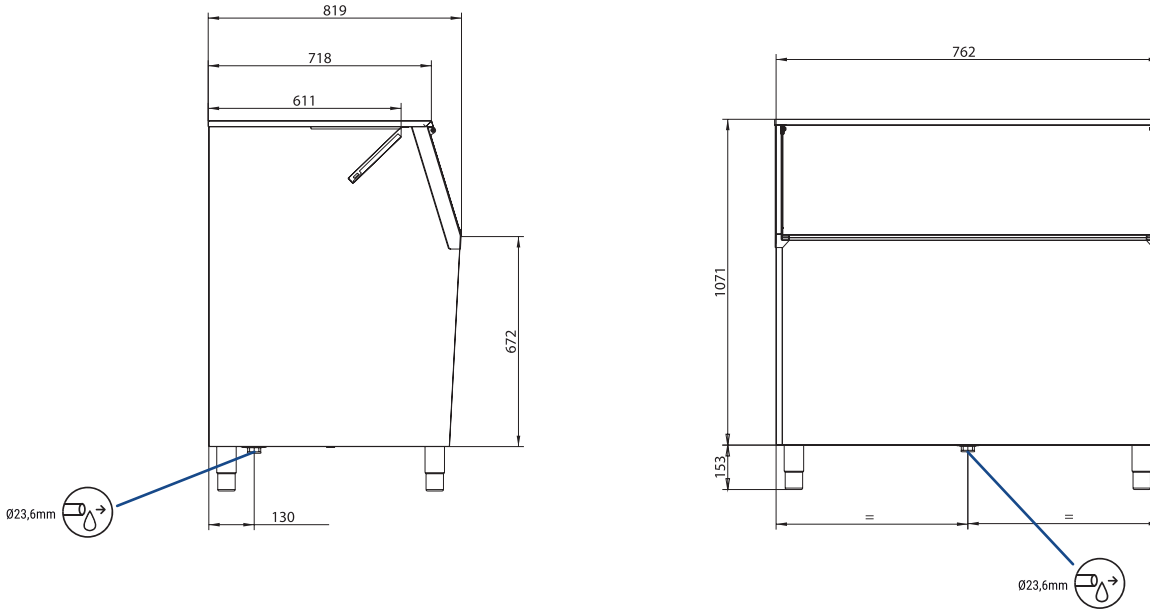

*All measurements in mm.
*Tutte le misure in mm.

ACCESSORIES ACCESSORI

INCLUSO



4 HEIGHT ADJUSTABLE
LEG KIT
KIT 4 PIEDINI ALTEZZA
REGOLABILE



LARGE SCOOP
PALA GRANDE



WATER OUTLET HOSE
TUBO DI SCARICO



DRAINAGE ELBOW
CURVA DI SCARICO



B 210	230	184	Width Depth Height*	762 819 1.071	56	Width Depth Height*	850 890 1.210	68	0,92
-------	-----	-----	---------------------------	---------------------	----	---------------------------	---------------------	----	------

*1.231 mm with legs
*1.231 mm con piedini