



B 400

















ICE BIN FOR MODULAR MACHINES

FEATURES CARACTERÍSTICAS

- ▶ **ICE BIN CAPACITY OF 390 KG.**
DEPÓSITO PARA HIELO CON CAPACIDAD DE 390 KG.
- ▶ **AISI 304 STAINLESS STEEL BINS.**
DEPÓSITO DE ACERO INOXIDABLE CALIDAD AISI 304.
- ▶ **VERY HARD SANITARY POLYETHYLENE VAT, RESISTANT TO BLOWS, AND SCRATCHES.**
CUBA INTERIOR DE POLIETILENO SANITARIO DE GRAN DUREZA, RESISTENTE A GOLPES, Y ROCES.
- ▶ **EASY CLEANING DESIGN®: SEAMLESS ONE-PIECE VAT WITH ROUNDED CORNERS, AVOIDING POSSIBLE DIRTY POINTS AND FACILITATING CLEANING.**
EASY CLEANING DESIGN®: CUBA INTERIOR SIN JUNTAS, DE UNA SOLA PIEZA, CON ESQUINAS REDONDEADAS, ELIMINANDO POSIBLES PUNTOS DE SUCIEDAD Y FACILITANDO LA LIMPIEZA.
- ▶ **DRAINAGE SYSTEM THAT COLLECTS AND DRIVES THE WATER TO THE DRAIN KEEPING THE BIN CLEAN & DRY.**
SISTEMA DE DRENAJE QUE RECOGE Y CONDUCE EL AGUA AL DESAGÜE MANTENIENDO EL SILO LIMPIO Y SECO.



RECOMMENDED MACHINES MÁQUINAS RECOMENDADAS

	SS/SK	FD/HD	PS	GR	SC
  RECOMMENDED RECOMENDADO	 2 SS150	 1/2 FD/HD215		 2 GR 220	 GR 400
		 FD/HD 315 SLIM		 GR 560	 1/2 GR 560 SPLIT
		 1/2 FD/HD 415		 1/2 GR 850 CO2 SPLIT	 GR1100 SPLIT
  NOT RECOMMENDED NO RECOMENDADO	 SS150			 GR 220	
	 SS400				



B 400

RIGHT SIDE VIEW
VISTA LATERAL DERECHA

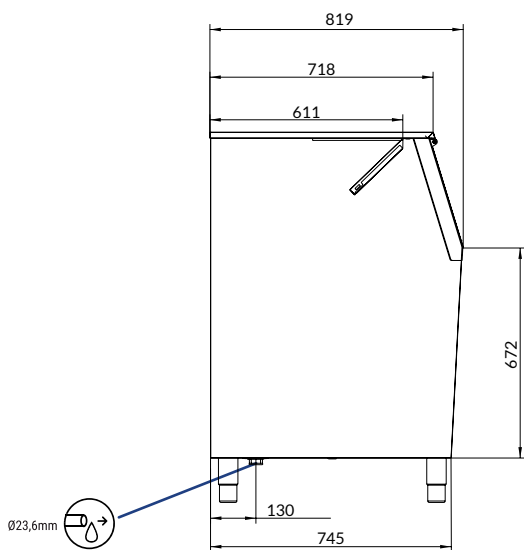

FRONTAL VIEW
VISTA FRONTAL

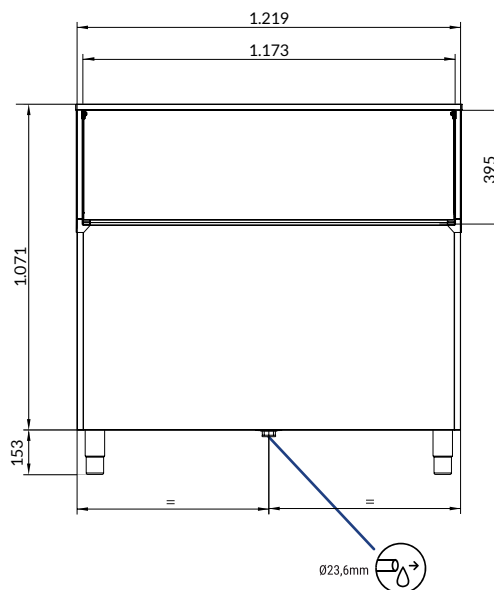

*All measurements in mm.
*Todas las cotas en mm.

ACCESSORIES ACCESORIOS

INCLUDED



4 HEIGHT ADJUSTABLE LEG KIT
KIT 4 PATAS ALTURA REGULABLE



LARGE SCOOP
PALA GRANDE



WATER OUTLET HOSE
MANGUERA DE DESAGÜE



DRAINAGE ELBOW
CODO DE DESAGÜE

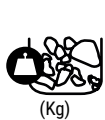

(Kg)



(Kg)



(mm)



(Kg)



(mm)



(Kg)

(m³)

B 400

390

312

Width 1.219
Depth 819
Height* 1.071

75

Width 1.300
Depth 890
Height* 1.210

97

1,40

*1.224 mm with legs
*1.224 mm con patas



ICETECH, S.A.
POL. IND. LA REVA, SECTOR 13, AV. GREMIS, 1
46394 RIBARROJA DE TURIA, VALENCIA, SPAIN
PHONE: +34 961 667 636 | FAX: +34 961 668 944
sales@icetechnice.com | www.icetechnice.com



SERVICE
SERVICIO ASISTENCIA TÉCNICA
service@icetechnice.com
Skype: ICETECH.Service
+34 961 667 639
8:00AM | 7:00PM



Subject to certain limitations
and exclusions. Only spare parts.
Sujeto a limitaciones y exclusiones.
Solo piezas de repuesto.



9001
14001



tecno
CERT