



MIB-1

ICE BAGGER KIT

FEATURES CARACTERÍSTICAS

- ▶ **THE ICETECH MIB-1 ICE BAGGER WILL MAKE YOUR ICE BAGGING A QUICK AND EASY OPERATION.**
LA EMBOLSADORA DE HIELO ICETECH MIB-1 HARÁ QUE EMBOLSAR EL HIELO SEA UNA OPERACIÓN RÁPIDA Y FÁCIL.
- ▶ **MADE OF ANODIZED ALUMINIUM.**
FABRICADA CON ALUMINIO ANODIZADO.
- ▶ **ICE CHUTE TUBE MADE OF POLYSTYRENE FOR ALIMENTARY PURPOSES.**
TUBO CAÍDA HIELO DE POLIESTIRENO ALIMENTARIO.
- ▶ **BAGS WITH A CAPACITY OF 4KG (275X550MM).**
BOLSAS CON CAPACIDAD DE 4KG (275X550MM).
- ▶ **ZIPPER BAGS WITH LAMINATED WIRE.**
CIERRE BOLSAS MEDIANTE ALAMBRE PLASTIFICADO.
- ▶ **COMPLEMENT: 2 KIT OF 50 BAGS & ZIPPERS.**
DOTACIÓN: 2 KIT DE 50 BOLSAS & CIERRES.



ACCESSORIES ACCESORIOS

INCLUDED



BAGS KIT
KIT DE BOLSAS



ZIPPERS KIT
KIT DE CIERRES



SMALL SCOOP
PALA PEQUEÑA

RECOMMENDED BINS DEPÓSITOS RECOMENDADOS



B 175



S 210



B 340



B 400



B 500



MIB -1

RIGHT SIDE VIEW
VISTA LATERAL DERECHA

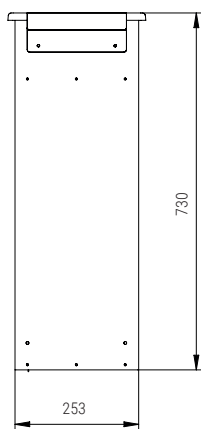

FRONTAL VIEW
VISTA FRONTAL

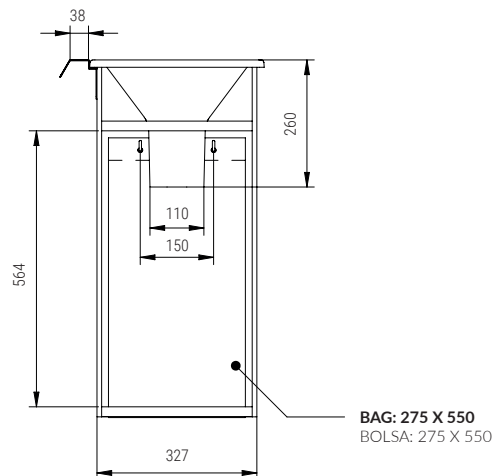



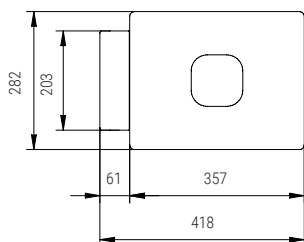



TOP VIEW
VISTA SUPERIOR



* All measurements in mm.
* Todas las cotas en mm.

MODELS
MODELOS

MIB-1

	 (mm)	 (Kg) (Lbs.)	 (mm)	 (mm)	 (Kg)	 (Kg) (m³)
Width	550	4 8,8	Width 357	Width 377	5,85	7 0,08
Depth	-		Depth 274	Depth 302		
Height	280		Height 730	Height 742		