











# FD/HD 110 230 V / 50 Hz

## SELF-CONTAINED ICE CUBE MACHINE

### FEATURES CARACTERÍSTICAS

- ▶ **PRODUCE FULL DICE ICE CUBES OR HALF DICE ICE CUBES.**  
PRODUCE CUBITOS DE DADO Y MEDIO DADO.
- ▶ **STIF: STRONG INOX FRAME. SOLID MACHINE STRUCTURE IN 4 COLUMNS WITH AISI 304 STAINLESS STEEL FRAME.**  
STIF: STRONG INOX FRAME. MÁQUINA CON SÓLIDA ESTRUCTURA DE 4 COLUMNAS Y CARROCEÍA EN ACERO INOXIDABLE AISI 304.
- ▶ **STRONGEST DOOR IN THE MARKET. MADE OF STAINLESS STEEL. OPENING AND DAMPING SYSTEM PATENTED BY ITV.**  
PUERTA MÁS SÓLIDA EN EL MERCADO. HECHA DE ACERO INOXIDABLE. SISTEMA DE APERTURA Y AMORTIGUACIÓN PATENTADO POR ITV.
- ▶ **FRONT VENTILATION CONCEPT: FRONTAL IN-OUT AIR SYSTEM ALLOWS 'BUILT IN' MACHINES.**  
CONCEPTO FRONT VENTILATION: VENTILACIÓN FRONTAL IN-OUT QUE PERMITE LA INSTALACIÓN ENCASTRADA DE LA MÁQUINA.
- ▶ **CLEANING SWITCH: ALLOWS CIRCULATION OF WATER WITH DESCALING PRODUCT (CALCLIN OR SIMILAR) WITHOUT COOLING.**  
BOTÓN DE LIMPIEZA: PERMITE RECIRCULAR EL AGUA CON EL DESINCRUSTANTE (CALCLIN O SIMILAR) SIN REFRIGERACIÓN.
- ▶ **"NEVER STOP" MOTOR PUMP DEVELOPED BY ITV. PUMP WITHOUT SEALS, WHICH AVOIDS DETERIORATION IN HARD WATER.**  
BOMBA "NEVER STOP" DESARROLLADA POR ITV. BOMBA SIN RETENES QUE EVITA SU DETERIORO EN AGUAS DURAS.
- ▶ **EASI: EASY ACCESS FOR SERVICE & INSTALLATION. ALL PANELS CAN BE DISASSEMBLED SEPARATELY.**  
EASI: EASY ACCESS FOR SERVICE & INSTALLATION. FÁCIL ACCESO A CUALQUIER PUNTO YA QUE TODOS LOS PANELES PUEDEN SER DESMONTADOS DE FORMA INDEPENDIENTE.
- ▶ **ON/OFF LIGHTED ROCKER SWITCH IN FRONT PANEL.**  
INTERRUPTOR LUMINOSO DE FUNCIONAMIENTO ON/OFF EN EL PANEL FRONTAL.
- ▶ **TROPICALIZED MACHINES (T CLASS) / HEIGHT ADJUSTABLE LEGS FROM 105MM TO 155MM.**  
MÁQUINAS TROPICALIZADAS (CLASE T) / PATAS DE ALTURA AJUSTABLE DE 105MM A 155MM.



	 24 H	 10°C (Kg)	 10°C (Kg)	 21°C (Kg)	 15°C (Kg)	 STOCK (Kg)	 (mm)	 (mm)	
FD/HD 110 A		119	110	35	Width 660	Width 745	<b>FD/HD 6gr</b> 23 mm (W) x 11 mm (D) x 26 mm (H) Average dimensions Dimensiones promedio		
FD/HD 110 W		119	110		Depth 700	Depth 770		<b>FD/HD 12gr</b> 26 mm (W) x 23 mm (D) x 26 mm (H) Average dimensions Dimensiones promedio	
					Height 832*	Height 970			

\* WITH LEGS 937/987 CON PATAS 937/987

### ACCESSORIES ACCESORIOS

#### INCLUDED



**WATER INLET HOSE**  
MANGUERA DE ENTRADA DE AGUA



**WATER OUTLET HOSE**  
MANGUERA DE DESAGÜE



**4 HEIGHT ADJUSTABLE LEG KIT**  
KIT 4 PATAS ALTURA REGULABLE



**WATER INLET FILTER GASKET**  
JUNTA DE FILTRO DE ENTRADA DE AGUA



**MEDIUM SCOOP**  
PALA MEDIANA

#### NOT INCLUDED (OPTIONAL)



**ANTI-LIMESCALE FILTER**  
FILTRO ANTICAL



**PARTICLE FILTER**  
FILTRO ANTIPARTÍCULAS



**ANTI-CHLORINE FILTER**  
FILTRO ANTICLORO



**ANTI-LIMESCALE + ANTI-CHLORINE FILTER CS101**  
FILTRO ANTICAL + ANTICLORO CS101



**C4 WATER SOFTENER**  
DESCALCIFICADOR C4



**CALCLIN 50 CLEANER**  
PRODUCTO ANTICAL



**4 WHEELS KIT**  
KIT 4 RUEDAS

RIGHT SIDE VIEW  
VISTA LATERAL DERECHA

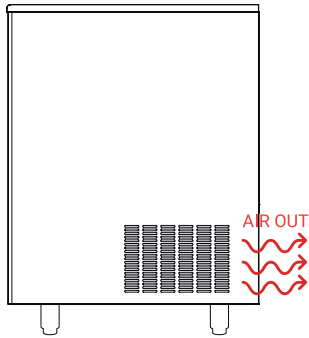

FRONTAL VIEW  
VISTA FRONTAL

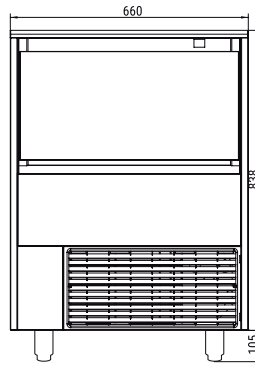

LEFT SIDE VIEW  
VISTA LATERAL IZQUIERDA

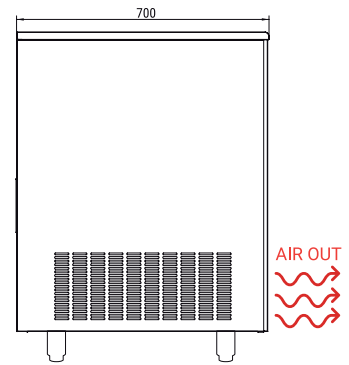

REAR VIEW  
VISTA TRASERA

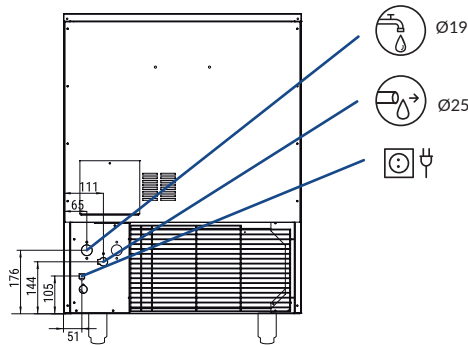

\* All measurements in mm.  
\* Todas las cotas en mm.

OPERATING CONDITIONS CONDICIONES DE OPERACIÓN

PRODUCTION 50Hz PRODUCCIÓN 50 Hz

±10% V

10°C/43°C

5°C/38°C

1 bar/6 bar

120/240 Ice cubes/cycle

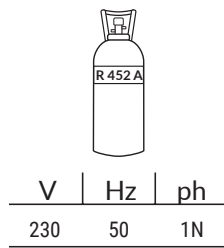

FD/HD 110 AIR COOLED

°C / °F	10° / 50°	15° / 60°	21° / 70°	30° / 86°
10° / 50°	106	100	95	90
21° / 68°	101	96	90	86
32° / 90°	90	85	79	74
43° / 109°	80	73	68	64

FD/HD 110 WATER COOLED

°C / °F	10° / 50°	15° / 60°	21° / 70°	30° / 86°
10° / 50°	107	100	95	90
21° / 68°	101	97	90	86
32° / 90°	90	85	83	81
43° / 109°	80	77	75	70

MODELS  
MODELOS

MODEL	ASHRAE CONDITIONS CONDICIONES ASHRAE	(W)	(BTU/h)	(W) 43°C	(n.)	(mm <sup>2</sup> )	FUSE	(Kwh)	(l/h)	HEAT REJECTED (W)	(BTU/h)	(Kg)	(Kg)	(m <sup>3</sup> )
FD/HD 110 A	Air Cooled	386	1.255	600	2	1,5	10	15,5	18,9 18,9	-	-	71	81	0,56
FD/HD 110 W	Water Cooled	386	1.255	650	2	1,5	10	13,6	49,2 49,2	-	-	71	81	0,56