











# FD/HD 415 230 V / 60 Hz

## MODULAR ICE CUBE MACHINE

### FEATURES CARACTERÍSTICAS

- ▶ **PRODUCES FULL DICE ICE CUBES OR HALF DICE ICE CUBES.**  
PRODUCE CUBITOS DE DADO Y MEDIO DADO.
- ▶ **HIGH EFFICIENT EVAPORATOR.**  
EVAPORADOR DE ALTA EFICIENCIA.
- ▶ **SMART WATER DISTRIBUTOR THAT IMPROVES DROP-OFF EFFICIENCY.**  
DISTRIBUIDOR DE AGUA INTELIGENTE QUE MEJORA LA EFICIENCIA EN EL DESPEGUE.
- ▶ **EASY ACCESS BY REMOVING THE PANELS WITH A SINGLE SCREWDRIVER.**  
FÁCIL ACCESO RETIRANDO LOS PANELES CON UN SOLO DESTORNILLADOR.
- ▶ **SMART ELECTRONIC BOARD CONTROLS EVERY PARAMETER IN THE MACHINE AND SHOWS THE DIAGNOSIS OF POSSIBLE INCIDENCES.**  
PLACA ELECTRÓNICA INTELIGENTE QUE CONTROLA LOS PARÁMETROS DE LA MÁQUINA Y MUESTRA EL DIAGNÓSTICO DE POSIBLES INCIDENCIAS.
- ▶ **ENERGY STAR, LOW POWER CONSUMPTION CERTIFICATION.**  
ENERGY STAR, CERTIFICADO DE BAJO CONSUMO ELÉCTRICO.
- ▶ **HIGH RESISTANCE EXTERNAL FRAME IN AISI 304 STAINLESS STEEL.**  
ESTRUCTURA DE ALTA RESISTENCIA EN ACERO INOXIDABLE AISI 304.



	 24 H	 10°C    10°C	 21°C    15°C	 (mm)	 (mm)	
FD/HD 415 A		424 (Kg)	405 (Kg)	Width 760 Depth 620 Height 762	Width 836 Depth 635 Height 874	<b>FD/HD 6gr</b> 23 mm (W) x 11 mm (D) x 26 mm (H) Average dimensions Dimensiones promedio
FD/HD 415 W		436	416			 <b>FD/HD 12gr</b> 26 mm (W) x 23 mm (D) x 26 mm (H) Average dimensions Dimensiones promedio

### ACCESSORIES ACCESORIOS

#### INCLUDED



WATER INLET FILTER GASKET  
JUNTA DE FILTRO DE ENTRADA DE AGUA



WATER INLET HOSE  
MANGUERA DE ENTRADA DE AGUA



WATER OUTLET HOSE  
MANGUERA DE DESAGÜE

#### NOT INCLUDED (OPTIONAL)



ANTI-LIMESCALE FILTER  
FILTRO ANTICAL



PARTICLE FILTER  
FILTRO ANTIPARTÍCULAS



ANTI-LIMESCALE + ANTI-CHLORINE FILTER CS101  
FILTRO ANTICAL + ANTICLORO CS101

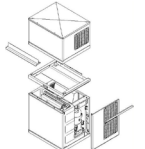

STACKING KIT  
KIT APILADO

### RECOMMENDED BINS DEPÓSITOS RECOMENDADOS

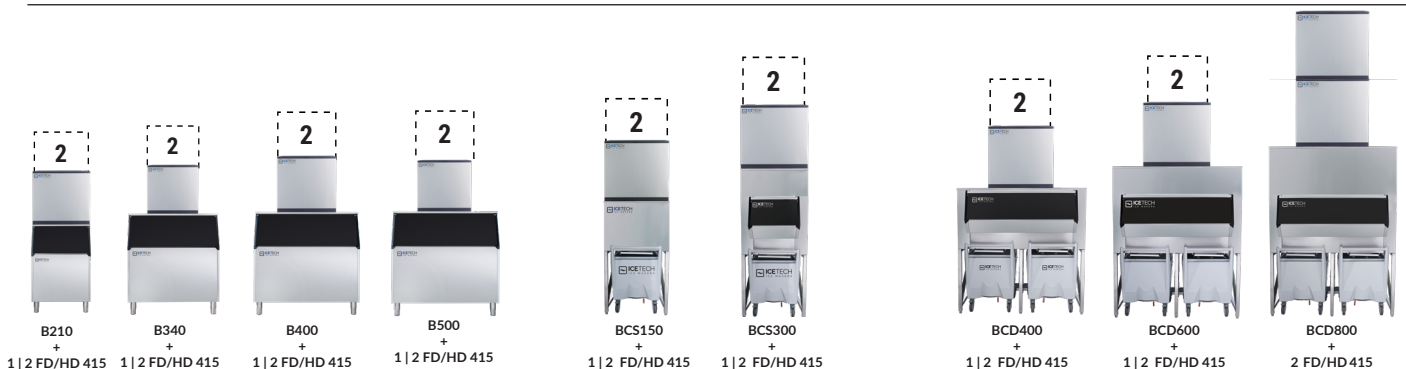

RIGHT SIDE VIEW  
VISTA LATERAL DERECHA

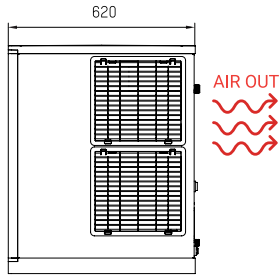

FRONTAL VIEW  
VISTA FRONTAL

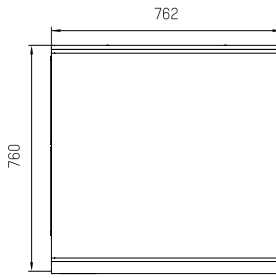

REAR VIEW  
VISTA TRASERA

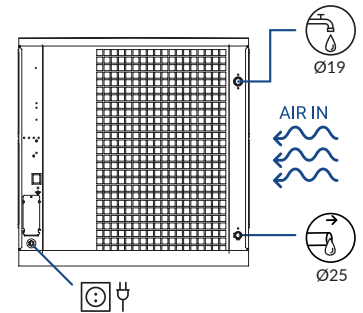

CENTRAL CROSS SECTION VIEW OF THE  
BASE  
VISTA DE LA BASE DESDE SECCIÓN  
CENTRAL

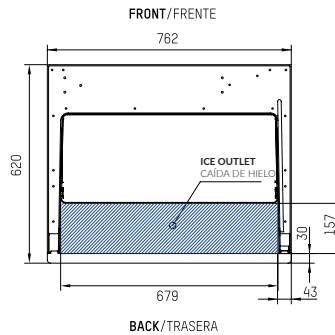

\* All measurements in mm.  
\* Todas las cotas en mm.

OPERATING CONDITIONS CONDICIONES DE OPERACIÓN

PRODUCTION 60Hz PRODUCCIÓN 60 Hz

±10% V

10°C/43°C

5°C/38°C

1 bar/6 bar

400/800 Ice cubes/cycle

V	Hz	ph
230	60	1N



FD/HD 415 AIR COOLED

°C / °F	10° / 50°	15° / 60°	21° / 70°	30° / 86°
10° / 50°	424	412	395	379
21° / 68°	413	405	386	368
32° / 90°	359	333	301	284
43° / 109°	293	259	232	217

FD/HD 415 WATER COOLED

°C / °F	10° / 50°	15° / 60°	21° / 70°	30° / 86°
10° / 50°	436	423	406	389
21° / 68°	425	416	397	378
32° / 90°	369	342	310	291
43° / 109°	301	266	239	223

MODELS  
MODELOS

FD/HD 415 A

FD/HD 415 W

ASHRAE CONDITIONS CONDICIONES ASHRAE	(W)	(BTU/h)	(W) 43°C	(n.)	(mm <sup>2</sup> )	FUSE	(Kwh)	(l/h)	HEAT REJECTED (W)	(BTU/h)	(Kg)	(Kg)	(m <sup>3</sup> )
FD/HD 415 A	11.185	38.185	1.690	3	2,5	15	9,9	17 17	3.505	11.960	105	110	0,53
FD/HD 415 W	11.185	38.185	1.690	3	2,5	10	9,9	110 110	3.505	11.960	105	110	0,53