

# FD/ HD 60











230 V / 50 Hz

## SELF-CONTAINED ICE CUBE MACHINE

### FEATURES CARACTERÍSTICAS

- ▶ **PRODUCE FULL DICE ICE CUBES OR HALF DICE ICE CUBES.**  
PRODUCE CUBITOS DE DADO Y MEDIO DADO.
- ▶ **STIF: STRONG INOX FRAME. SOLID MACHINE STRUCTURE IN 4 COLUMNS WITH AISI 304 STAINLESS STEEL FRAME.**  
STIF: STRONG INOX FRAME. MÁQUINA CON SÓLIDA ESTRUCTURA DE 4 COLUMNAS Y CARROCEÍA EN ACERO INOXIDABLE AISI 304.
- ▶ **STRONGEST DOOR IN THE MARKET. MADE OF STAINLESS STEEL. OPENING AND DAMPING SYSTEM PATENTED BY ITV.**  
PUERTA MÁS SÓLIDA EN EL MERCADO. HECHA DE ACERO INOXIDABLE. SISTEMA DE APERTURA Y AMORTIGUACIÓN PATENTADO POR ITV.
- ▶ **FRONT VENTILATION CONCEPT: FRONTAL IN-OUT AIR SYSTEM ALLOWS 'BUILT IN' MACHINES.**  
CONCEPTO FRONT VENTILATION: VENTILACIÓN FRONTAL IN-OUT QUE PERMITE LA INSTALACIÓN ENCASTRADA DE LA MÁQUINA.
- ▶ **CLEANING SWITCH: ALLOWS CIRCULATION OF WATER WITH DESCALING PRODUCT (CALKLIN OR SIMILAR) WITHOUT COOLING.**  
BOTÓN DE LIMPIEZA: PERMITE RECIRCULAR EL AGUA CON EL DESINCRUSTANTE (CALKLIN O SIMILAR) SIN REFRIGERACIÓN.
- ▶ **"NEVER STOP" MOTOR PUMP DEVELOPED BY ITV. PUMP WITHOUT SEALS, WHICH AVOIDS DETERIORATION IN HARD WATER.**  
BOMBA "NEVER STOP" DESARROLLADA POR ITV. BOMBA SIN RETENES QUE EVITA SU DETERIORO EN AGUAS DURAS.
- ▶ **EASI: EASY ACCESS FOR SERVICE & INSTALLATION. ALL PANELS CAN BE DISASSEMBLED SEPARATELY.**  
EASI: EASY ACCESS FOR SERVICE & INSTALLATION. FÁCIL ACCESO A CUALQUIER PUNTO YA QUE TODOS LOS PANELES PUEDEN SER DESMONTADOS DE FORMA INDEPENDIENTE.
- ▶ **ON/OFF LIGHTED ROCKER SWITCH IN FRONT PANEL.**  
INTERRUPTOR LUMINOSO DE FUNCIONAMIENTO ON/OFF EN EL PANEL FRONTAL.
- ▶ **TROPICALIZED MACHINES (T CLASS) / HEIGHT ADJUSTABLE LEGS FROM 105MM TO 155MM.**  
MÁQUINAS TROPICALIZADAS (CLASE T) / PATAS DE ALTURA AJUSTABLE DE 105MM A 155MM.



	 24 H	 10°C (Kg)	 10°C (Kg)	 21°C (Kg)	 15°C (Kg)	 STOCK (Kg)	 (mm)	 (mm)	
FD/HD 60 A		65	60	20	20	20	Width 535	Width 620	<b>FD/HD 6gr</b> 23 mm (W) x 11 mm (D) x 26 mm (H) Average dimensions Dimensiones promedio
FD/ HD 60 W		65	60				Depth 595	Depth 660	<b>FD/HD 12gr</b> 26 mm (W) x 23 mm (D) x 26 mm (H) Average dimensions Dimensiones promedio
							Height 789*	Height 920	

\* WITH LEGS 894/944 CON PATAS 894/944

### ACCESSORIES ACCESORIOS

#### INCLUDED



**WATER INLET HOSE**  
MANGUERA DE ENTRADA DE AGUA



**WATER OUTLET HOSE**  
MANGUERA DE DESAGÜE



**4 HEIGHT ADJUSTABLE LEG KIT**  
KIT 4 PATAS ALTURA REGULABLE



**WATER INLET FILTER GASKET**  
JUNTA DE FILTRO DE ENTRADA DE AGUA



**MEDIUM SCOOP**  
PALA MEDIANA

#### NOT INCLUDED (OPTIONAL)



**ANTI-LIMESCALE FILTER**  
FILTRO ANTICAL



**PARTICLE FILTER**  
FILTRO ANTIPARTÍCULAS



**ANTI-CHLORINE FILTER**  
FILTRO ANTICLORO



**ANTI-LIMESCALE + ANTI-CHLORINE FILTER CS101**  
FILTRO ANTICAL + ANTICLORO CS101



**C4 WATER SOFTENER**  
DESCALCIFICADOR C4



**CALKLIN 50 CLEANER**  
PRODUCTO ANTICAL



**4 WHEELS KIT**  
KIT 4 RUEDAS

# TECHNICAL SCHEME ESQUEMA TÉCNICO

FH/HD 60

**RIGHT SIDE VIEW**  
VISTA LATERAL DERECHA

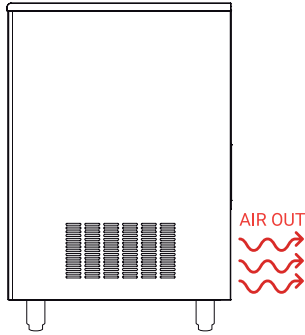

**FRONTAL VIEW**  
VISTA FRONTAL

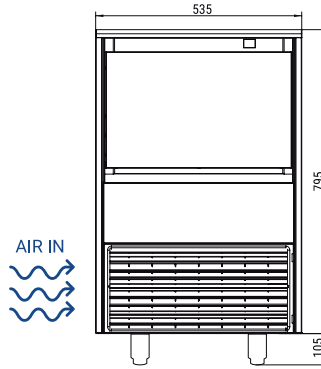

**REAR VIEW**  
VISTA TRASERA

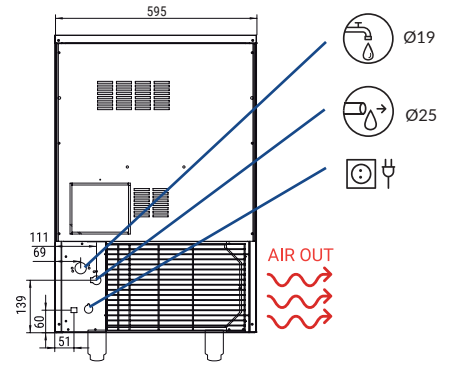

\* All measurements in mm.  
\* Todas las cotas en mm.

## OPERATING CONDITIONS CONDICIONES DE OPERACIÓN

PRODUCTION 50Hz PRODUCCIÓN 50 Hz

±10% V

10°C/43°C

5°C/38°C

1 bar/6 bar

75/150 Ice cubes/cycle

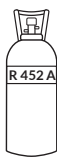

V	Hz	ph
230	50	1N

**FD/HD 60 AIR COOLED**

°C / °F	10° / 50°	15° / 60°	21° / 70°	30° / 86°
10° / 50°	60	57	53	48
21° / 68°	56	52	49	45
32° / 90°	46	43	41	36
43° / 109°	36	32	29	26

**FD/HD 60 WATER COOLED**

°C / °F	10° / 50°	15° / 60°	21° / 70°	30° / 86°
10° / 50°	61	57	53	48
21° / 68°	56	53	49	47
32° / 90°	46	43	43	40
43° / 109°	36	33	32	29

### MODELS MODELOS

	ASHRAE CONDITIONS CONDICIONES ASHRAE	(W)	(BTu/h)	(W) 43°C	(n.)	(mm <sup>2</sup> )	FUSE	100 Kg (Kwh)	(l/h) FULL   HALF	HEAT REJECTED (W) (BTu/h)	(Kg)	(Kg)	(m <sup>3</sup> )
FD/HD 60 A		184	627	430	2	1,5	10	17	5   5	-   -	52	61	0,38
FD/HD 60 W		184	627	470	2	1,5	10	17	33   33	-   -	52	61	0,38

0000\_ict/enes\_07/E/21



ICETECH, S.A.  
POL. IND. LA REVA, SECTOR 13, AV. GREMIS, 1  
46394 RIBARROJA DE TURIA, VALENCIA, SPAIN  
PHONE: +34 961 667 636 | FAX: +34 961 668 944  
sales@icetechice.com | www.icetechice.com



SERVICE  
SERVICIO ASISTENCIA TÉCNICA  
sales@icetechice.com  
Skype: ICETECH.Service  
+34 961 667 639  
8:00AM | 7:00PM



Subject to certain limitations  
and exclusions. Only spare parts.  
Sujeto a limitaciones y exclusiones.  
Solo piezas de repuesto



VERTICAL SYSTEM  
SISTEMA VERTICAL