

# FD/ HD 60















230 V / 50 Hz

## SELF-CONTAINED ICE CUBE MACHINE

### FEATURES CARATTERISTICHE

- ▶ **PRODUCES FULL DICE ICE CUBES OR HALF DICE ICE CUBES.**  
PRODUCE CUBETTI A DADO E A MEZZO DADO.
- ▶ **STIF: STRONG INOX FRAME. SOLID MACHINE STRUCTURE IN 4 COLUMNS WITH AISI 304 STAINLESS STEEL FRAME.**  
STIF: STRONG INOX FRAME. MACCHINA CON ASSETTO SOLIDO A 4 COLONNE E STRUTTURA IN ACCIAIO INOSSIDABILE AISI 304.
- ▶ **STRONGEST DOOR IN THE MARKET. MADE OF STAINLESS STEEL. OPENING AND DAMPING SYSTEM PATENTED BY ITV.**  
LO SPORTELLINO PIÙ SOLIDO SUL MERCATO. FABBRICATO IN ACCIAIO INOSSIDABILE. SISTEMA DI APERTURA E SMORZAMENTO BREVETTATO DA ITV.
- ▶ **FRONT VENTILATION CONCEPT: FRONTAL IN-OUT AIR SYSTEM ALLOWS 'BUILT IN' MACHINES.**  
CONCETTO FRONT VENTILATION: VENTILAZIONE FRONTALE IN-OUT CHE PERMETTE DI INCASSARE LA MACCHINA.
- ▶ **CLEANING SWITCH: ALLOWS CIRCULATION OF WATER WITH DESCALING PRODUCT (CALKLIN OR SIMILAR) WITHOUT COOLING.**  
PULSANTE DELLA PULIZIA: PERMETTE IL RICIRCOLO DELL'ACQUA CON UN PRODOTTO DISINCROSTANTE (CALKLIN O SIMILE) SENZA REFRIGERAZIONE.
- ▶ **"NEVER STOP" MOTOR PUMP DEVELOPED BY ITV. PUMP WITHOUT SEALS, WHICH AVOIDS DETERIORATION IN HARD WATER.**  
POMPA "NEVER STOP" IDEATA DA ITV. POMPA SENZA GUARNIZIONI CHE EVITA IL DETERIORAMENTO IN ACQUE DURE.
- ▶ **EASI: EASY ACCESS FOR SERVICE & INSTALLATION. ALL PANELS CAN BE DISASSEMBLED SEPARATELY.**  
EASY ACCESS FOR SERVICE & INSTALLATION. ACCESSO FACILE A QUALSIASI PUNTO GRAZIE AI PANNELLI ESTRAIBILI SINGOLARMENTE.
- ▶ **ON/OFF LIGHTED ROCKER SWITCH IN FRONT PANEL.**  
SPIA LUMINOSA DI FUNZIONAMENTO ON/OFF SUL PANNELLO FRONTALE.
- ▶ **TROPICALIZED MACHINES (T CLASS) / HEIGHT ADJUSTABLE LEGS FROM 105MM TO 155MM.**  
MACCHINE TROPICALIZZATE (CLASSE T) / PIEDINI CON ALTEZZA REGOLABILE DA 105MM A 155MM.



	 24 H	 10°C (Kg)	 10°C (Kg)	 21°C (Kg)	 15°C (Kg)	 STOCK (Kg)	 (mm)	 (mm)	
FD/HD 60 A		65	60	20	Width 535	Width 620			
FD/ HD 60 W		65	60		Depth 595	Depth 660			
					Height 789*	Height 920			

**HD 6 gr**  
23 mm (W) x 11 mm (D) x 26 mm (H)  
Average dimensions Dimensiones promedio

**FD 12 gr**  
26 mm (W) x 23 mm (D) x 26 mm (H)  
Average dimensions Dimensiones promedio

\* WITH LEGS 894/944 CON PIEDINI 894/944

### ACCESSORIES ACCESSORI

#### INCLUSO



**WATER INLET HOSE**  
TUBO INGRESSO DELL'ACQUA



**WATER OUTLET HOSE**  
TUBO DI SCARICO



**4 HEIGHT ADJUSTABLE LEG KIT**  
KIT 4 PIEDINI ALTEZZA REGOLABILE



**WATER INLET FILTER GASKET**  
GIUNTURA DEL FILTRO DI INGRESSO DELL'ACQUA



**MEDIUM SCOOP**  
PALA MEDIA

#### NON INCLUSO (OPTIONAL)



**ANTI-LIMESCALE FILTER**  
FILTRO ANTICALCARE



**ANTI-LIMESCALE + ANTI-CHLORINE FILTER CS101**  
FILTRO ANTICALCARE + ANTICLORO CS101



**ANTI-CHLORINE FILTER**  
FILTRO ANTICLORO



**PARTICLE FILTER**  
FILTRO ANTIPARTICOLATO



**C4 WATER SOFTENER**  
DECALCIFICATORE C4



**CALKLIN 50 CLEANER**  
PRODOTTO ANTICALCARE



**4 WHEELS KIT**  
KIT 4 ROTELLE

# TECHNICAL SCHEME PIANO TECNICO

FH/HD 60

**RIGHT SIDE VIEW**  
VISTA LATERALE DESTRA

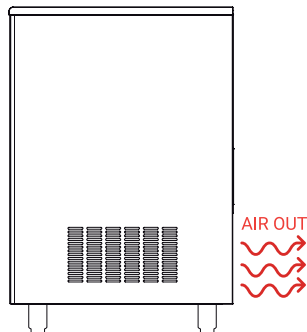

**FRONTAL VIEW**  
VISTA FRONTALE

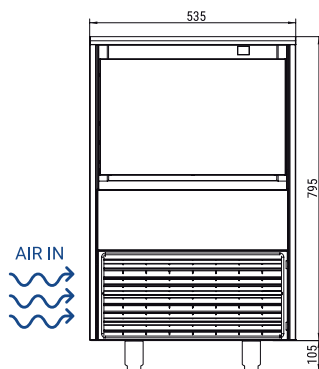

**REAR VIEW**  
VISTA POSTERIORE

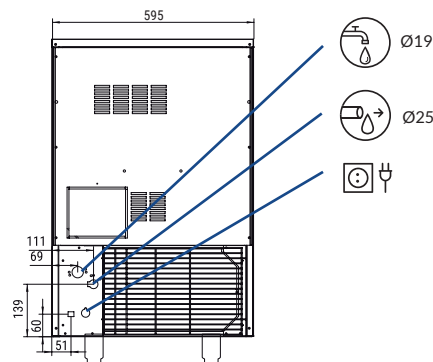

\* All measurements in mm.  
\* Tutte le misure in mm.

## OPERATING CONDITIONS CONDIZIONI PER IL FUNZIONAMENTO

PRODUCTION 50Hz PRODUZIONE 50 Hz

±10% V

10°C/43°C

5°C/38°C

1 bar/6 bar

75/150 Ice cubes/cycle

R 452 A		
V	Hz	ph
230	50	1N

**FD/HD 60 AIR COOLED**

°C / °F	10° / 50°	15° / 60°	21° / 70°	30° / 86°
10° / 50°	60	57	53	48
21° / 68°	56	52	49	45
32° / 90°	46	43	41	36
43° / 109°	36	32	29	26

**FD/HD 60 WATER COOLED**

°C / °F	10° / 50°	15° / 60°	21° / 70°	30° / 86°
10° / 50°	61	57	53	48
21° / 68°	56	53	49	47
32° / 90°	46	43	43	40
43° / 109°	36	33	32	29

### MODELS MODELLI

	ASHRAE CONDITIONS CONDICIONES ASHRAE	(W)	(BTU/h)	(W) 43°C	(n.)	(mm <sup>2</sup> )	FUSE	(Kwh)	(l/h)	FULL   HALF	HEAT REJECTED (W)	(BTU/h)	(Kg)	(Kg)	(m <sup>3</sup> )
FD/HD 60 A	10°/50°	184	627	430	2	1,5	10	17	5	5	-	-	52	61	0,38
FD/HD 60 W	5°/38°	184	627	470	2	1,5	10	17	33	33	-	-	52	61	0,38



ICETECH, S.A.  
POL. IND. LA REVA, SECTOR 13, AV. GREMIS, 1  
46394 RIBARROJA DE TURIA, VALENCIA, SPAIN  
PHONE: +34 961 667 636 | FAX: +34 961 668 944  
sales@iceteche.com | www.iceteche.com



SERVICE  
SERVIZIO ASSISTENZA TECNICA  
sales@iceteche.com  
Skype: ICETECH.Service  
+34 961 667 639  
8:00AM | 7:00PM



Subject to certain limitations  
and exclusions. Only spare parts.  
Soggetta a limitazioni e revoca.  
Solo parti di ricambio.



VERTICAL SYSTEM  
SISTEMA VERTICALE