

# FD/HD 90













230 V / 50 Hz

## SELF-CONTAINED ICE CUBE MACHINE

### FEATURES CARATTERISTICHE

- ▶ **PRODUCES FULL DICE ICE CUBES OR HALF DICE ICE CUBES.**  
PRODUCE CUBETTI A DADO E A MEZZO DADO.
- ▶ **STIF: STRONG INOX FRAME. SOLID MACHINE STRUCTURE IN 4 COLUMNS WITH AISI 304 STAINLESS STEEL FRAME.**  
STIF: STRONG INOX FRAME. MACCHINA CON ASSETTO SOLIDO A 4 COLONNE E STRUTTURA IN ACCIAIO INOSSIDABILE AISI 304.
- ▶ **STRONGEST DOOR IN THE MARKET. MADE OF STAINLESS STEEL. OPENING AND DAMPING SYSTEM PATENTED BY ITV.**  
LO SPORTELLINO PIÙ SOLIDO SUL MERCATO. FABBRICATO IN ACCIAIO INOSSIDABILE. SISTEMA DI APERTURA E SMORZAMENTO BREVETTATO DA ITV.
- ▶ **FRONT VENTILATION CONCEPT: FRONTAL IN-OUT AIR SYSTEM ALLOWS 'BUILT IN' MACHINES.**  
CONCETTO FRONT VENTILATION: VENTILAZIONE FRONTALE IN-OUT CHE PERMETTE DI INCASSARE LA MACCHINA.
- ▶ **CLEANING SWITCH: ALLOWS CIRCULATION OF WATER WITH DESCALING PRODUCT (CALCLIN OR SIMILAR) WITHOUT COOLING.**  
PULSANTE DELLA PULIZIA: PERMETTE IL RICIRCOLO DELL'ACQUA CON UN PRODOTTO DISINCROSTANTE (CALCLIN O SIMILE) SENZA REFRIGERAZIONE.
- ▶ **"NEVER STOP" MOTOR PUMP DEVELOPED BY ITV. PUMP WITHOUT SEALS, WHICH AVOIDS DETERIORATION IN HARD WATER.**  
POMPA "NEVER STOP" IDEATA DA ITV. POMPA SENZA GUARNIZIONI CHE EVITA IL DETERIORAMENTO IN ACQUE DURE.
- ▶ **EASI: EASY ACCESS FOR SERVICE & INSTALLATION. ALL PANELS CAN BE DISASSEMBLED SEPARATELY.**  
EASY ACCESS FOR SERVICE & INSTALLATION. ACCESSO FACILE A QUALSIASI PUNTO GRAZIE AI PANNELLI ESTRAIBILI SINGOLARMENTE.
- ▶ **ON/OFF LIGHTED ROCKER SWITCH IN FRONT PANEL.**  
SPIA LUMINOSA DI FUNZIONAMENTO ON/OFF SUL PANNELLO FRONTALE.
- ▶ **TROPICALIZED MACHINES (T CLASS) / HEIGHT ADJUSTABLE LEGS FROM 105MM TO 155MM.**  
MACCHINE TROPICALIZZATE (CLASSE T) / PIEDINI CON ALTEZZA REGOLABILE DA 105MM A 155MM.



	 24 H	 10°C (Kg)	 10°C (Kg)	 21°C (Kg)	 15°C (Kg)	 STOCK (Kg)	 (mm)	 (mm)	 <b>HD 6 gr</b> 23 mm (W) x 11 mm (D) x 26 mm (H) Average dimensions Dimensiones promedio
FD/HD 90 A		87	80	35	Width 660	Width 745	 <b>FD 12 gr</b> 26 mm (W) x 23 mm (D) x 26 mm (H) Average dimensions Dimensiones promedio		
FD/HD 90 W		87	80		Depth 700	Depth 770			
					Height 832*	Height 970			

\* WITH LEGS 937/987 CON PIEDINI 937/987

### ACCESSORIES ACCESSORI

#### INCLUSO



**WATER INLET HOSE**  
TUBO INGRESSO DELL'ACQUA



**WATER OUTLET HOSE**  
TUBO DI SCARICO



**4 HEIGHT ADJUSTABLE LEG KIT**  
KIT 4 PIEDINI ALTEZZA REGOLABILE



**WATER INLET FILTER GASKET**  
GIUNTURA DEL FILTRO DI INGRESSO DELL'ACQUA



**MEDIUM SCOOP**  
PALA MEDIA

#### NON INCLUSO (OPTIONAL)



**ANTI-LIMESCALE FILTER**  
FILTRO ANTICALCARE



**ANTI-LIMESCALE + ANTI-CHLORINE FILTER CS101**  
FILTRO ANTICALCARE + ANTICLORO CS101



**ANTI-CHLORINE FILTER**  
FILTRO ANTICLORO



**PARTICLE FILTER**  
FILTRO ANTIPARTICOLATO



**C4 WATER SOFTENER**  
DECALCIFICATORE C4



**CALCLIN 50 CLEANER**  
PRODOTTO ANTICALCARE



**4 WHEELS KIT**  
KIT 4 ROTELLE

# TECHNICAL SCHEME PIANO TECNICO

FD/HD 90

**RIGHT SIDE VIEW**  
VISTA LATERALE DESTRA

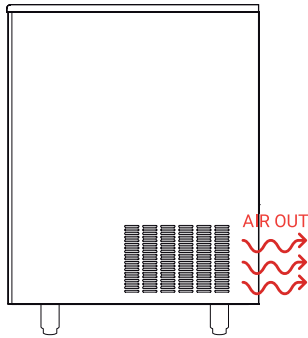

**FRONTAL VIEW**  
VISTA FRONTALE

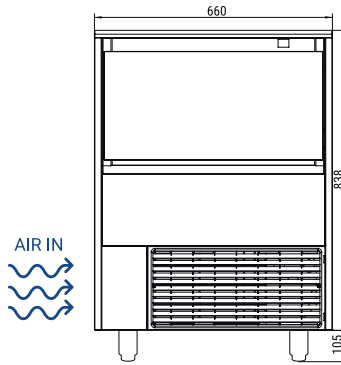

**LEFT SIDE VIEW**  
VISTA LATERALE SINISTRO

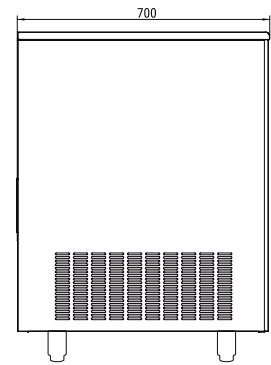

**REAR VIEW**  
VISTA POSTERIORE

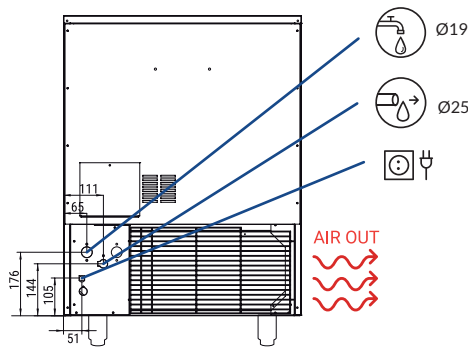

\* All measurements in mm.  
\* Tutte le misure in mm.

## OPERATING CONDITIONS CONDIZIONI PER IL FUNZIONAMENTO

PRODUCTION 50Hz PRODUZIONE 50 Hz

±10% V

10°C/43°C

5°C/38°C

1 bar/6 bar

120/240 Ice cubes/cycle

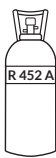

V	Hz	ph
230	50	1N

**FD/HD 90 AIR COOLED**

°C / °F	10° / 50°	15° / 60°	21° / 70°	30° / 86°
10° / 50°	95	90	87	82
21° / 68°	90	84	81	77
32° / 90°	75	70	66	62
43° / 109°	72	59	55	50

**FD/HD 90 WATER COOLED**

°C / °F	10° / 50°	15° / 60°	21° / 70°	30° / 86°
10° / 50°	96	90	87	82
21° / 68°	90	85	81	81
32° / 90°	75	70	69	68
43° / 109°	72	62	61	55

## MODELS MODELLI

	ASHRAE CONDITIONS CONDICIONES ASHRAE	(W)	(BTU/h)	(W) 43°C	(n.)	(mm <sup>2</sup> )	FUSE	100 Kg (Kwh)	(l/h) FULL   HALF	HEAT REJECTED (W)	(BTU/h)	(Kg)	(Kg)	(m <sup>3</sup> )
FD/HD 90 A		245	836	550	2	1,5	10	17	11   11	-	-	68	81	0,56
FD/HD 90 W		245	836	580	2	1,5	10	13	45   45	-	-	68	81	0,56

**ICETECH**  
ICE MAKERS

ICETECH, S.A.  
POL. IND. LA REVA, SECTOR 13, AV. GREMIS, 1  
46394 RIBARROJA DE TURIA, VALENCIA, SPAIN  
PHONE: +34 961 667 636 | FAX: +34 961 668 944  
sales@icetechice.com | www.icetechice.com

**ICETECH**  
ICE MAKERS SERVICE

SERVICE  
SERVIZIO ASSISTENZA TECNICA  
sales@icetechice.com  
Skype: ICETECH.Service  
+34 961 667 639  
8:00AM | 7:00PM

**2 YEARS**  
WARRANTY

Subject to certain limitations  
and exclusions. Only spare parts.  
Soggetta a limitazioni e revoca.  
Solo parti di ricambio.

**CE**  
ISO 9000



**VERTICAL SYSTEM**  
SISTEMA VERTICALE