

Warnings

This appliance is intended for domestic and similar uses, such as kitchen areas for staff in shops, offices and other work environments; on farms, as well as for the use of customers in hotels, motels and other residential establishments; in hostels; catering and similar commercial applications.

The installation of this appliance must be carried out by the Technical Assistance Service. The socket plug must be in an accessible place.

When installing the appliance, make sure that the power cord is not trapped and is not damaged.

Do not place power strips or portable power packs on the back of the appliance.

Always disconnect the machine from the mains before proceeding with any cleaning or maintenance operation.

Any modification that may be necessary in the electrical installation for the perfect connection of the machine must be carried out exclusively by professionally qualified and authorized personnel.

Any use by the producer of ice cubes other than to produce ice, using drinking water, is considered inadequate.

Modifying or attempting to modify this appliance, in addition to voiding any form of warranty, is extremely dangerous.

The appliance should not be used by young children or disabled persons without supervision. It should not be used outdoors or exposed to rain.

The machine must be connected using the power cord supplied with the equipment.

This appliance must be grounded to avoid possible shocks to people or damage to the equipment. It must be grounded according to local and/or national regulations and legislation in each case. The manufacturer will not be held liable for damage caused by the failure to ground the installation.

Do not store explosive substances such as aerosol cans with a flammable propellant in this appliance

WARNING: All items in the packaging (plastic bags, cardboard boxes and wooden pallets) should not be left within the reach of children as they are a potential source of danger.

WARNING: Keep all ventilation openings in the appliance enclosure or in the built-in structure free of obstructions.

WARNING: Do not use mechanical devices or other means to speed up the defrosting process, other than those recommended by the manufacturer.

WARNING: Do not damage the coolant fluid circuit.

WARNING: Do not use electrical appliances inside food/ice storage compartments, unless they are of the type recommended by the manufacturer.

WARNING: In order to reduce flammability hazards, installation of this appliance should only be carried out by an appropriately qualified person.

This appliance may be used by children 8 years of age and older and by persons with reduced physical, sensory, or mental capacities or lack of experience and knowledge, if they have been given appropriate supervision or training regarding the safe use of the appliance and understand the hazards involved. Cleaning and maintenance to be carried out by the user should not be carried out by children without supervision.

Unsupervised children should not play with the device.

If the power cord is damaged, it must be replaced by the manufacturer, its after-sales service or similar qualified personnel in order to avoid a hazard.

New hoses supplied with the appliance should be used, old hoses should not be reused.

Before servicing the machine, make sure you have turned off the machine via the rear two-position switch.

Before the manual cleaning cycle, make sure you have switched off the machine via the two-position rear switch.

During the automatic cleaning cycle, the machine must be connected to the power supply and to a water source.

To ensure the efficiency of this machine and its proper operation, it is essential to adhere to the manufacturer's instructions, especially with regard to maintenance and cleaning operations, which should only be carried out by qualified personnel.

WARNING: The intervention of unqualified persons, in addition to being dangerous, can cause serious damage. In case of breakdown, contact your dealer. We recommend that you always use original spare parts.

The Company reserves the right to make changes to specifications and design without prior notice



This signal indicates that the machine should be connected only to the drinking water supply.



This sign indicates "Fire Hazard/Flammable Materials", due to the use of flammable refrigerant for the operation of the appliance.

In addition, for compressor-stage appliances with flammable refrigerants, the following warnings should be observed:

- Keep ventilation openings free of obstructions, both in the appliance housing and in the structure in which it is integrated.
- Do not use mechanical devices or other means to speed up the defrosting process, except those recommended by the manufacturer.
- Do not damage the refrigerant circuit.
- Do not use electrical appliances inside the food storage compartment, except those of the type recommended by the manufacturer.
- Do not store explosive substances, such as aerosol cans with flammable propellant in this appliance.

In the event of a flammable refrigerant leak:

- Avoid flames near the appliance.
- Do not turn on/off or plug/disconnect the appliance.
- Immediately ventilate the area where the appliance is located by opening doors and windows.
- Call an authorized service center.

Disposal of ice-making equipment: the advice is to respect the environmental regulations of each country regarding the correct disposal of electrical and electronic equipment such as this. The user who wishes to dispose of this equipment must contact the manufacturer and follow the appropriate method of differentiated collection for the corresponding subsequent treatments.

Sound Pressure Level:

- The A-weighted emission sound pressure level is below 70 dB(A).

User troubleshooting guide

COMPACT MODELS:

PROBLEM	PROBABLE CAUSE	SOLUTION
None of the electrical parts work.	The machine is unplugged.	Plug in the machine and check the electrical outlet.
	The curtain is open. The ice is touching the warehouse tube.	Remove ice from the warehouse.
	The curtain is open. There is no ice touching the warehouse tube.	Adjust the curtain, it could have gotten caught and not been able to close properly.
There is no water in the reservoir.	No water enters.	Check the water intake.
	Blocked hose or water inlet valve filter.	Check and clean.
The ice slab is empty or too thick.	Mismatched cycle time.	Adjusting the Board Switches
Difficulties in removing the ice slab in the take-off phase.	Poorly leveled unit (tilted backwards).	Level; lower the front.
	Lack of take-off time.	Adjust the take-off time through the switches.
The fall of water into the evaporator is not a uniform pattern.	Distributor with dirt or lime.	Carry out the lime cleaning procedure. Remove and clean the distributor (pull the two clips on the sides of the distributor).
The unit starts and stops alternately.	The security pressure switch opens.	Clean the air condenser (underneath behind the front grille).
For other problems call after-sales service.		

MODULAR MODELS

PROBLEM	PROBABLE CAUSE	SOLUTION
None of the electrical parts work.	The machine is unplugged.	Plug in the machine and check the electrical outlet.
	Rear switch on OFF.	Set the back switch to ON.
	Front work switch in "0" position.	Set the switch to the "ice" position (position I).
All the electrical parts work, but not the compressor (the water does not cool down).	Front work switch in "cleaning" position (position II).	Set the switch to the "ice" position (position I).
	Front work switch in position "1", but previously the washing process had not been completed.	L2 is flashing, you have to wait until the machine does not do the three rinses to make sure that there is no cleaning product left in the refrigeration circuit of the machine, once this cycle is finished, L2 is turned off and the machine starts its normal operation autonomously.
There is no water in the reservoir.	No water enters.	Check the water intake.
	Blocked hose or water inlet valve filter.	Check and clean.
There is not enough water to end the cycle.	Water level detector too low.	Raise the water level detector (stainless steel bar next to the pump).
	Faulty bleed valve (check for leaks in the drain during the cold phase)	Disassemble and clean.
	Splash leaks from the curtain.	Check the position of the curtain.
The water overflows the tank.	The detector is too high or too high.	Adjust and clean.
Empty or overly thin ice slab.	Detector of misadjusted thickness.	Adjust and clean.
Difficulty removing the slab on take-off.	The unit is poorly leveled (tilted back).	Level; lower the front.
The fall of water into the evaporator is not a uniform pattern.	Distributor with dirt or lime.	Carry out the lime cleaning procedure. Remove and clean the distributor (pull the two clips on the sides of the distributor).
Low production.	Dirty condenser.	Clean (also check the air and water temperature)
The unit stops after a short time running.	The security pressure switch opens.	Clean the air condenser (at the rear).
For other problems call after-sales service.		

Original instructions

Introduction

Thank you for purchasing a cube ice maker from the 'Vertical System' range. You have purchased one of the most reliable ice machines on the market today. Please read the instructions contained in this manual carefully, they contain important information regarding safety during installation, use and maintenance

Machine Reception

Inspect the packaging externally. If it is broken or damaged, claim the carrier. To determine if the machine is damaged, unpack it in the presence of the carrier and record in the receipt document, or in a separate letter, the damage that the machine may have

Always state the number of the machine and model. This issue is printed in three places:

Packaging: On the outside it bears a label with the manufacturing number.

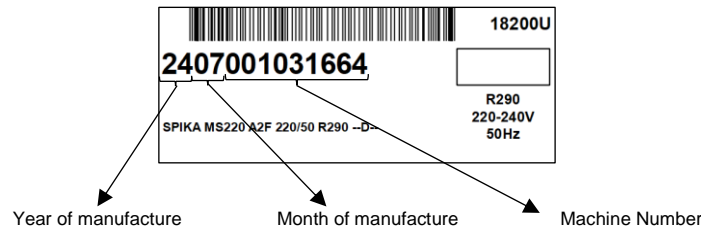

(1) **Outside of the machine:** On the back, on a label the same as the previous one.

(2) **Nameplate:** On the back of the machine.

S/N: 2407001031664				
<small>L394903271</small>				
SPIKA MS220 A2F 220/50 R290				
<small>CC: 18200U</small>				
vol.	Ph.	Hz.	N.	Dis.
220-240		50	4	16
ref.	g.	kg.	lit.	lit.
R290	135	795		5
<small>condensation-condensation-condensation</small>			Made in Spain/EU	
AIRE-AIR-LUFT			<small>07-24</small>	
<small>Insulation blowing gas: HFO-1236mzz / HFO-1233zd</small>				

Verify that the installation KIT is complete inside the machine, consisting of:

- Ice shovel, drain hose, four legs (only in compact models) and manual.
- Warranty and serial number.
- Water connection and filter gaskets.

Installation

1- LOCATION OF THE MACHINE

This ice maker is not designed to work outdoors. It should not be located near ovens, grills, or other equipment that generates a lot of heat.

The machines are intended to operate at an ambient temperature between 10°C (41°F) and 43°C (109.4°F). Below the minimum temperatures there may be difficulties in the detachment of the cubes. Above maximum temperatures, compressor life is shortened and production decreases considerably.

Compact air-cooled models take the air from the front and expel it through the rear and front grille thanks to their new structure and oblique condenser placement. Do not place anything on the manufacturer or in front of the front grille. If the front air intake is insufficient, the outlet is completely or partially obstructed, or if it is to receive hot air from another appliance due to its placement, we strongly recommend, if it is not possible to change the location of the machine, to install a water condensate.

Modular air-cooled models take air through the rear of the machine and direct it through the side grilles. In the event that it is not possible to respect the minimum recommended distances (see figure 3.3 for these models, we recommend installing a water-cooled one).

The location should allow sufficient space for water, drain, and electrical connections at the rear of the ice maker. It is important that the water supply pipe does not pass near heat sources so as not to lose production.

The 48" modular models must be lifted as follows:

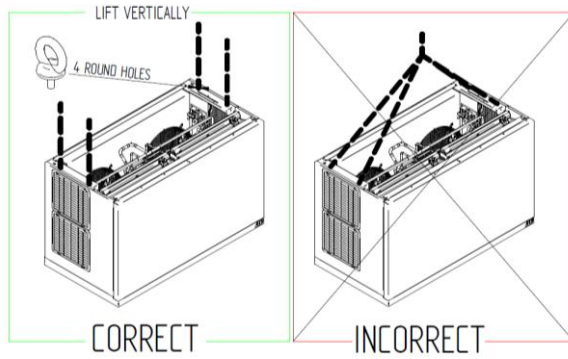

For the lifting and transport of the rest of the models, suitable equipment or machinery must be used for this purpose, such as pallet trucks, forklifts, etc., to ensure the lifting of the machine without causing any damage to the equipment or personnel carrying out the operation. The equipment must be properly packed and protected to avoid cosmetic or mechanical damage during transport.

2.- LEVEL THE ICE MACHINE

Use a level above the machine to ensure that the equipment is perfectly level.

For compact models only:

Thread the leveling legs onto the bottom of the machine as much as possible. Move the machine to its final position. Use a level above the machine. Rotate each foot as needed to level the machine from front to back and left to right.

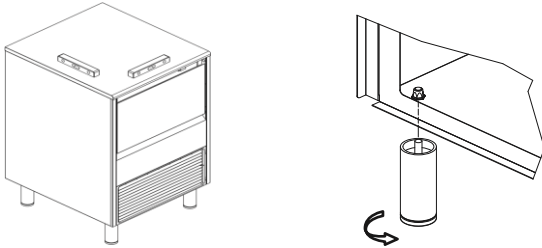

3.-MINIMUM OBSTACLE DISTANCE

Below you can see the minimum recommended distances for efficient operation and service

COMPACT MODELS

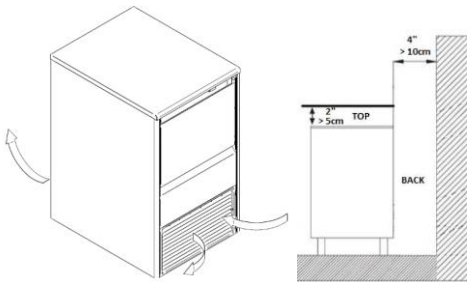

MODULAR MODELS

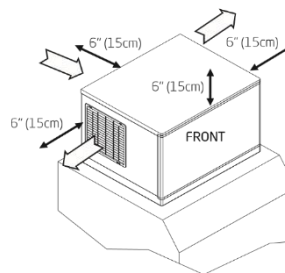

4.-CONNECTION DIAGRAM

The location should leave sufficient space for water, drain, and electrical connections at the rear of the machine.

COMPACT MODELS MODULAR MODELS

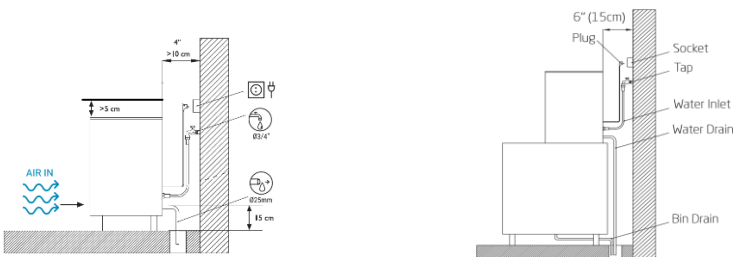

5.-CONNECTION TO THE WATER NETWORK

Water quality influences the periods between cleanings and the life of the product (mainly in water-condensed units). Compact models also have a noticeable influence on the appearance, hardness and taste of the ice. The water conditions of the premises may need water treatment to reduce limescale formation, improve the taste and transparency of the ice. If a water filtration system is installed, refer to the instructions supplied with the filtration system.

The water inlet pressure should be between 10 and 85 psi (0.7 and 6 bar). If the pressure exceeds these values, install a pressure regulator.

WARNING: The machine must be level.

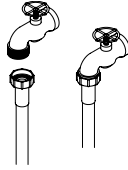

6.-DRAINAGE

The drain should be lower than the machine, at least 150 mm (5.9 in).

The drain pipe should have an inner diameter of 30 mm (1.18 in) and a minimum slope of 3 cm/metre (0.36 in/ft), see figure.

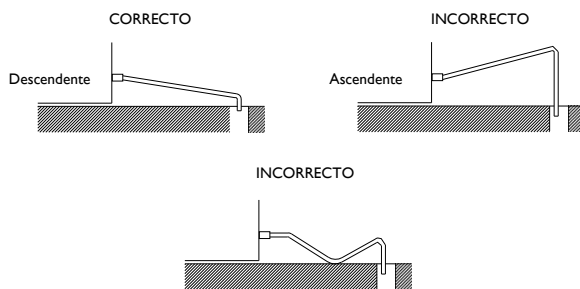

7.-ELECTRICAL CONNECTION

This appliance must be grounded to avoid possible shocks to people or damage to the equipment. It must be grounded according to local and/or national regulations and legislation in each case.

The manufacturer will not be held liable for damage caused by the failure to ground the installation.

If the power cord is damaged, it must be replaced with a special cord or assembly to be supplied by the manufacturer or after-sales service. Such replacement must be carried out by qualified technical service.

The machine should be positioned in such a way that a minimum gap is left between the back and the wall to allow access to the cable plug in a comfortable and safe manner.

Prevent the opportune socket outlet. It is advisable to install a switch and the appropriate fuses.

The voltage is marked on the rating plate and on the technical sheets in this manual. Variations in voltage greater than 10% of the voltage indicated on the board may cause breakdowns or prevent the machine from starting.

8.-INSTALLATION OF MODULAR EQUIPMENT ON BINS

Modular fabricators must be installed on tanks or bins, following the instructions contained in this manual.

The strength and stability of the container-machine(s) assembly must be verified, as well as the fixation of the elements.

Follow the bin manufacturer's instructions.

The equipment needs to be sealed to the bin according to FDA requirements with a silicone or weatherstrip to establish proper operation. The contact surface between the top of the bin and the bottom of the appliance must be uniform and sealed to ensure correct sanitary conditions. It is recommended:

- Clean the contact areas well to ensure that there are no traces of dust or liquids that could affect the sealing material.
- Place the weatherstripping or silicone evenly, following the manufacturer's instructions.

Once sealed according to this procedure, the result is intended to prevent the spillage of liquids on adjacent surfaces of the floor or top from passing under the inaccessible parts of the equipment.

START-UP

(1) Pre-Check

- Is the machine level?
- Is the voltage and frequency the same as the board?
- Are the drains connected and working?
- Are room temperature and water temperature between the following values?

	ENVIRONMENT	WATER
MAXIMUM	43° C / 109° F	35°C / 95° F
MINIMUM	10° C / 43° F	5°C / 35° F

- e) Is the water pressure adequate?

MINIMUM	1 Bar (0.1 MPa or 14 psig) psig
MAXIMUM	6 Bar (0.6 Mpa or 85 psig)

NOTE: If the water inlet pressure is greater than 6 bar (85 psi) install a pressure reducer.

Modular machines have a signaling display that indicates the status of the machine, it is located on the front of the machine, on the bed, as can be seen in the following representation.

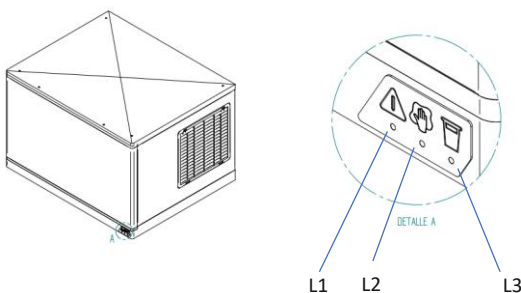

- | | | |
|-------------|---|---------------------------|
| L1 (red) | → | LED Alarm |
| L2 (orange) | → | Maintenance/cleaning LEDs |
| L3 (yellow) | → | Full Warehouse LED |

When the machine is switched on, the LEDs light up sequentially from L1 to L3 and turn off immediately to check that the LEDs are working and that the machine has actually been turned on.

L1, turns on every time an error occurs in the machine, in some cases turning the machine off and on through the rear switch resets the error. If the problem persists once the machine has been turned off and on, contact the technical support.

L2, if switch 2 is ON, turns on steadily if six months of operation have passed since the last maintenance. In addition, it flashes during the machine's cleaning cycle, as explained in the *Maintenance and Cleaning* section.

L3, It turns on fixed every time the machine is stopped by full ice warehouse.

2.- Commissioning

Once you have followed the installation instructions (ventilation, room conditions, temperatures, water quality, etc.) proceed as follows:

- Open the water shut-off valve. Check that there are no leaks.
- For compact models, open the door and remove the protective elements found in the curtain. For modular models, remove the two locking screws from the top of the machine, remove the front panel and remove the protective elements found on the curtain and on the thickness detector.
- Verify that the curtain moves freely. For modular models, also check that the thickness detector moves freely.
- Connect the machine to the mains.
- For compact models: press the switch on the front of the machine. For modular models: press the switch on the back of the machine and set the work switch (ice-clean) to position I.
- Check that there are no vibrations or frictions in the elements.
- Verify that the water falls into the evaporator evenly and that all the ice cubes are adequately wet.
- Close the door (for compact models) / Place the front panel in place (for modular models).
- For modular models: check the ice slab with the drawings below. In the event that the thickness detector needs to be adjusted, turn the thickness adjustment screw clockwise to increase the thickness of the bridge. Rotate counterclockwise to reduce bridge thickness. For compact models, adjust the switches on the board.

MODULAR MODELS

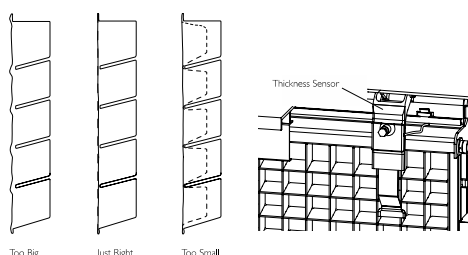

COMPACT MODELS

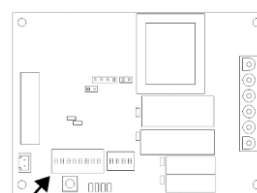

Damage caused due to lack of maintenance and cleaning is not included in the warranty.

Operating sequence

- Initial start-up: the first time the machine is started, the ignition sequence has a delay of 30 min. This starts with the collection cycle, which ensures that the water tray is full.
- Freeze cycle: the compressor is turned on. The water circulates from the water tray to the upper distributor, passing through each mold of the cubes, where it freezes. In models for under-counter mounting, the freezing time is a programmed period: it can be adjusted according to the table above. For modular models, this time depends on the adjustment of the thickness sensor.
- Collection cycle: the hot gas valve is opened and at the same time the water inlet valve is activated for a certain time to fill the water tray with the appropriate amount. The block of ice breaks off from the evaporator and falls into the container. With the opening of the curtain, the harvesting phase ends. The freeze sequence is then started again. The 48" modular machines have two curtains and the only difference in operation is that the take-off cycle ends only if the two curtains have been opened and closed, the moment the last curtain closes, the other freezing sequence begins.
- When the storage container is full, the ice block cannot fall and the curtain remains open. The machine will shut down until a sufficient amount of ice is removed from the storage container and the curtain closes again. On 48" modular machines, a single open curtain is enough for the machine to stop, until the curtain is closed again.

Maintenance and cleaning

It is the user's responsibility to maintain the ice machine and ice storage in proper sanitary conditions.

Ice machines also occasionally require cleaning the circuit through which the water circulates with a specific chemical. This product dissolves the limescale buildup that forms during the ice making process.

Disinfect the ice store as frequently as required by sanitary laws and whenever the machine is cleaned and disinfected.

The machine's water circuit should be cleaned and disinfected at least 2 times a year.

WARNING: Do not mix cleaning and disinfecting solutions together.

WARNING: Wear rubber gloves and safety goggles when handling with the cleaning or disinfection product.

WARNING: The unit must always be unplugged during manual cleaning and manual disinfection procedures.

(Cleaning the Water Distribution System for Compact Models)

Set the master switch to the OFF position after the ice has fallen from the evaporator at the end of the take-off phase, or put it directly in the OFF position and let the ice from the evaporator melt.

WARNING: Never use anything to force ice from the evaporator.

Remove the rear metal cover and top panel (if necessary to facilitate cleaning operations).

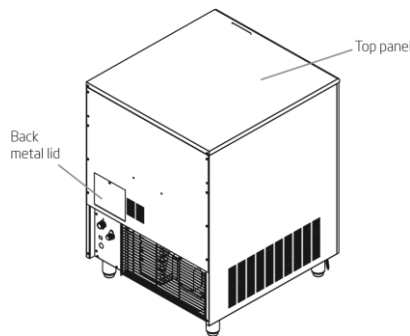

- 1) Remove ice from the stock warehouse.
- 2) Remove the auxiliary drain pipe near the pump and empty the water tank. Return it to its original position to prevent water from falling.

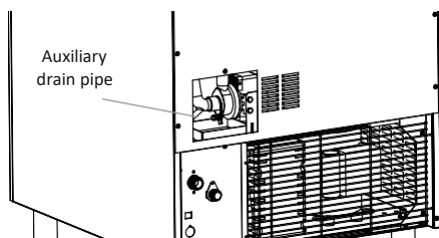

- 3) Prepare a solution of a product suitable for cleaning machines (lime). Do not use hydrochloric acid. We recommend the use of a product that removes limescale and prepared according to the manufacturer's instructions.
- 4) Refill the water tank with the solution.

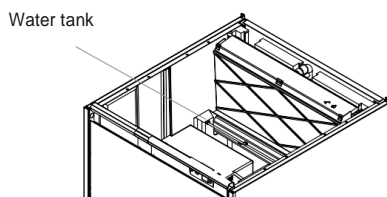

- 5) Press the button on the electronic board (see figure) and at the same time turn on the machine to activate the pump. Leave the circular solution on for 30-40 minutes and then turn off the machine.

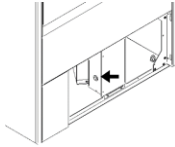

- 6) Disconnect the power supply and water supply.
- 7) Remove the auxiliary drain pipe and purge the solution that removes limescale and debris. Put it back in its place.
- 8) Mix enough solution to clean the parts and the inside of the areas in contact with water.
- 9) Remove the curtain.

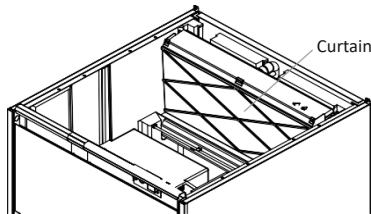

- 10) Clean all surfaces of the curtain with the cleaning product using a brush (not wire) or cloth. Rinse all areas with water.
- 11) Clean all surfaces inside the cold compartment (including the ice store) with the cleaning solution using a brush or cloth. Rinse all areas with water.
- 12) Mix a disinfectant solution using a food hypochlorite solution to form a 100 to 200 ppm free chlorine solution.
- 13) Disinfect all surfaces of the curtain by sufficiently applying the disinfectant solution with a cloth or sponge.
- 14) Disinfect all surfaces of the cold compartment (including the ice store) by sufficiently applying the disinfectant solution with a cloth or sponge.
- 15) Putting the curtain in position
- 16) Connect the power cord and water supply.
- 17) Fill the water tank with the disinfectant solution.
- 18) Start the machine to activate the pump. Leave the circular solution for 20 minutes and turn off.
- 19) Remove the auxiliary drain pipe and purge the disinfectant solution and residue. Place again. Fill the tank with water and operate the machine to allow the water to circulate for 5 minutes and then turn off the machine. Repeat this operation two more times to clarify thoroughly.
- 20) Remove the auxiliary pipe to drain. Replace it and fill the tank with water to ensure that the pump is working properly.
- 21) Operate the compressor switch (position I).
- 22) Place the metal back cover and top cover in position.
- 23) Operate the machine and discard the first two harvests.

ICE MAGAZINE CLEANING (FOR COMPACT MODELS)

- 1) Unplug the machine, turn off the water tap and empty the ice store.
- 2) Use the cleaning solution to clean all surfaces of the warehouse. Use a brush or cloth. Then rinse all areas thoroughly with clean water.
- 3) Use the disinfectant solution to disinfect all surfaces in the ice store. Use a brush or cloth.
- 4) Rinse with plenty of water, dry, start the machine and turn on the water tap.

CONDENSER CLEANING

(1) Air Condenser

- 1) Unplug the machine and turn off the water tap.
- 2) For compact models, remove the front grille by pressing the two clips located on the right side (see figure).

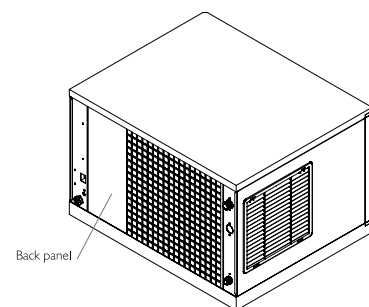
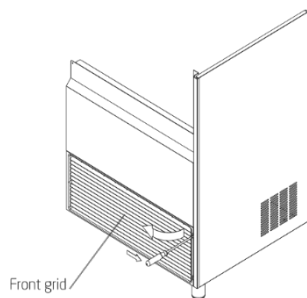

- 3) Clean the condenser using a vacuum cleaner, soft brush, or low-pressure air. Clean from bottom to top, not side to side. Be careful not to bend the fins of the condenser.

(2) Water Condenser

The water condenser may need cleaning due to limescale build-up. The cleaning procedure requires special pumps and solutions. These must be carried out by qualified maintenance or service personnel.

CLEANING THE OUTSIDE OF THE MACHINE

Clean the area around the machine as often as necessary to keep it clean. A sponge with detergent and water can be used to remove dust and dirt from the outside of the machine. Dry with a clean, soft cloth. A specific cleaner for stainless steel can be used if necessary.

CHECK FOR WATER LEAKS

Whenever the machine is intervened, check all the water connections, the condition of the clamps and hoses in order not to leave leaks and prevent breakages and floods.

Cleaning the Water Distribution System for Modular Models

- 1) Set the work switch (ice-clean) to the OFF position (position 0) after the ice falls from the evaporator at the end of the take-off phase or set the switch to the OFF position and let the ice in the evaporator melt.

WARNING: Never use anything to force ice from the evaporator. It could be damaged

- 2) Remove the front panel

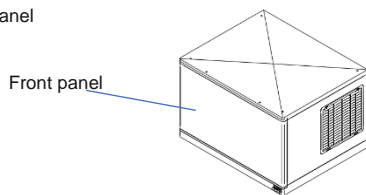

- 3) Prepare a solution of a product suitable for cleaning machines (lime). Do not use hydrochloric acid. We recommend the use of a product that removes limescale and prepared according to the manufacturer's instructions. In modular models we recommend preparing a pre-solution (e.g. 0.15L) according to the manufacturer's instructions with the total amount of product required for the water tank and adding water because the machine will not refill the tank independently.
- 4) To start the cleaning cycle, move the work switch to the cleaning position (position II). The orange L2 LED on the display will light up and flash. The machine drains the tank.

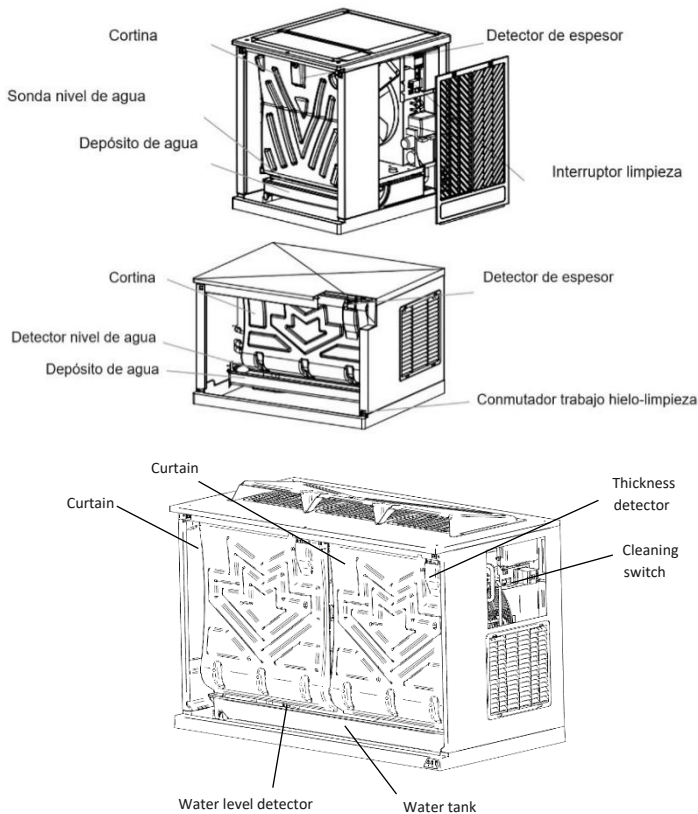

- 5) Once the tank drain is finished, the orange LED will flash more quickly for 5 minutes, during this time the technician has to pour the cleaning solution into the water tank.
- 6) After 5 minutes, the L2 will flash again at a normal frequency and the machine will continue the washing process autonomously, circulating the cleaning product

and finishing the process with three rinses.

- 7) At the end of the three rinses, the wash cycle is over and the orange L2 LED stops flashing, it will remain on solid.
- 8) Move the three-position switch to 0 (stand by) and disconnect the power cord and water supply. L2 is turned off.
- 9) Mix a disinfectant solution.
- 10) Remove the curtain and water tank.
- 11) Clean the metal surfaces, thickness detector, water level detector, adjustment screw, water pump electrode, curtain and water reservoir with the cleaning solution using a brush (not wire) or cloth.

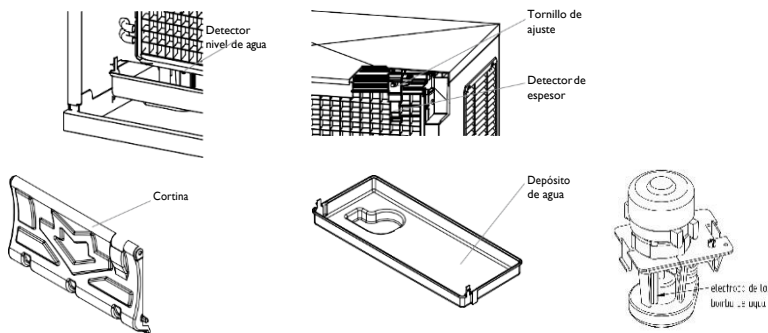

- 12) Clean the surfaces inside the cold compartment (including walls, plastic parts of the evaporator, distributor,) and the front panel with the cleaning solution using a brush or cloth.
- 13) Mix a disinfectant solution using a food hypochlorite solution to form a 100 to 200 ppm free chlorine solution.
- 14) Disinfect all surfaces of the thickness detector, water level detector, water pump electrode, curtain and water tank by applying plenty of solution using a cloth or sponge.
- 15) Disinfect the interior surfaces of the cold compartment (including walls, plastic parts of the evaporator, distributor) and the front panel by applying the solution using a cloth or sponge.
- 16) Place the water tank and curtain in their normal position.
- 17) Connect the power cord and water supply.
- 18) Repeat the same washing process started in point 4, changing the solution.
To start a disinfection cycle, move the work switch to the cleaning position (II). The orange L2 LED will start flashing, the machine drains the tank.
- 19) Once it finishes emptying, the L2 LED will flash more frequently for 5 minutes. During that time, the technician has to pour the solution into the water tank and add water to obtain a solution as indicated in point 13.
- 20) After 5 minutes, the L2 will flash again at a normal frequency and the machine will continue the washing process autonomously, circulating the cleaning product and finishing the process with three rinses.
- 21) Once the machine has finished the wash cycle, the orange L2 LED will stop flashing and stay on solid.
- 22) Place the panel in position.
- 23) Place the work switch in the ON position (position I) and discard the first two crops.