

SC 1000









THREE PHASE
400 V / 50 Hz

MODULAR FLAKE ICE MACHINE

FEATURES CARACTERÍSTICAS

- ▶ **PRODUCES COLD AND DRY FLAT FLAKES. FLAKE THICKNESS MAY BE ADJUSTED BETWEEN 1.5 mm AND 3 mm**
▶ PRODUCE ESCAMAS PLANAS MUY FRÍAS Y SECAS. EL ESPESOR PUEDE REGULARSE ENTRE 1.5 Y 3 mm
- ▶ **BASED ON A STATIC CYLINDER WHICH IS FREE FROM SWIVEL JOINTS (HELICAL REAMER) COUPLED WITH A MILLING TOOL THAT DETACHES THE ICE WITHOUT ANY STRAINED OR FORCED MOVEMENTS**
▶ FUNCIONAMIENTO BASADO EN UN CILINDRO ESTÁTICO SIN JUNTAS GIRATORIAS (HELICAL REAMER) Y CON UNA FRESA QUE DESPEGA EL HIELO SIN TENSIONES NI ESFUERZOS
- ▶ **THE MOST EFFICIENT EVAPORATOR OF THE MARKET, LESS ENERGY CONSUMPTION AND HIGHER ICE PRODUCTION**
▶ EL EVAPORADOR MAS EFICIENTE DEL MERCADO, MENOR GASTO ENERGÉTICO, MAYOR PRODUCCIÓN DE HIELO
- ▶ **ELECTRONIC STOP SYSTEM / ELECTRICAL CONTROL PANEL / DRIVE DIRECT GEAR MOTOR / MAGNETIC DRIVE PUMP / LOW WATER SAFETY DEVICE**
▶ SISTEMA DE PARO ELECTRÓNICO / CUADRO ELÉCTRICO DE REGULACIÓN / MOTORREDUCTOR DE ATAQUE DIRECTO / BOMBA DE ARRASTRE MAGNÉTICO / SEGURIDAD ANTE FALTA DE AGUA
- ▶ **STAINLESS STEEL SOLEPLATE**
▶ BANCADA DE ACERO INOXIDABLE
- ▶ **CONTROLLERS TO DETECT: LOW WATER LEVEL, TEMPERATURE RISE DUE TO MOTOR OVERLOAD OR FULL VAT**
▶ CONTROLES PARA DETECTAR: FALTA DE NIVEL DE AGUA, AUMENTO DE TEMPERATURA POR SOBRESFUERZO EN EL MOTORREDUCTOR O POR LLENADO DE ALMACÉN



	 24 H	 10°C	 10°C	 21°C	 15°C			
	(Kg)	(Kg)	(Kg)	(Kg)	(mm)	(mm)		
SC 1000		1.100	1.000	Width 1.360 Depth 1.050 Height 1.000	Width 1.580 Depth 1.290 Height 1.290	FLAKE ICE -7°C Ice Temperature		

ACCESSORIES ACCESORIOS

INCLUDED



WATER INLET FILTER GASKET
JUNTA DE FILTRO DE ENTRADA DE AGUA



WATER INLET HOSE
MANGUERA DE ENTRADA DE AGUA



WATER OUTLET HOSE
MANGUERA DE DESAGÜE

NOT INCLUDED (OPTIONAL)



ICE DROP CHUTE
TUBO DE CAÍDA DE HIELO



SALT DOSING PUMP WITH TANK
BOMBA DOSIFICADORA DE SAL CON DEPÓSITO



REMOTE SWITCH FILTER
INTERRUPTOR REMOTO



REMOTE SWITCH & WEEKLY PROGRAMMER
INTERRUPTOR REMOTO CON PROGRAMADOR SEMANAL



EXTERNAL STOP FULL BIN PHOTO CELL
SENSOR DE PARO EXTERNO POR LLENADO

RECOMMENDED BINS DEPÓSITOS RECOMENDADOS



BCD400 + SC 1000



BCD600 + SC 1000



BCD800 + SC 1000

SC 1000

RIGHT SIDE VIEW
VISTA LATERAL DERECHA

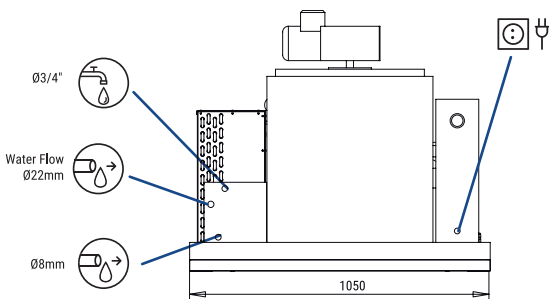

FRONTAL VIEW
VISTA FRONTAL

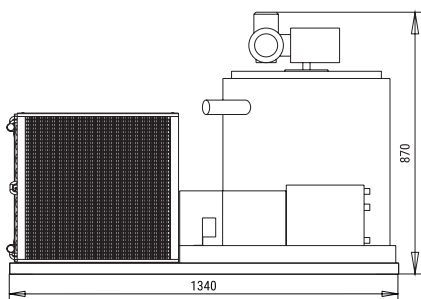

LEFT SIDE VIEW
VISTA LATERAL IZQUIERDA

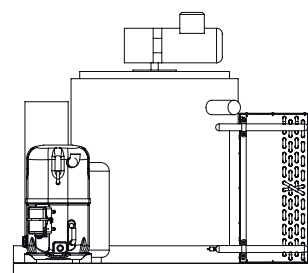

CENTRAL CROSS SECTION VIEW OF THE BASE
VISTA DE LA BASE DESDE SECCIÓN CENTRAL

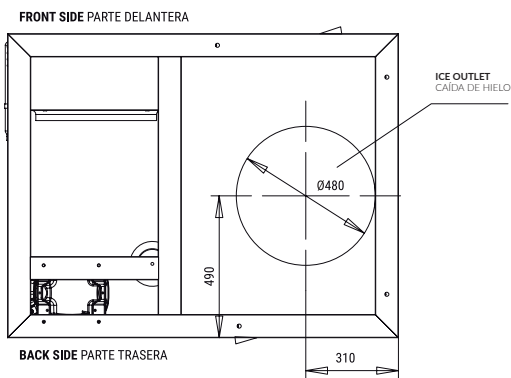

* All measurements in mm.
* Todas las cotas en mm.

OPERATING CONDITIONS CONDICIONES DE OPERACIÓN

PRODUCTION 50Hz PRODUCCIÓN 50 Hz

Icon	Value	SC 1000					SC 1000				
		10°	15°	21°	30°	10°	15°	21°	30°		
⚡	±10% V	10°	15°	21°	30°	10°	15°	21°	30°		
🏠	10°C/43°C	50°	60°	70°	86°	50°	60°	70°	86°		
🔥	5°C/38°C	1100	1400	900	830	1023	1302	837	772		
💧	1 bar/6 bar	21°	1090	1000	875	790	21°	1014	930	814	735
		32°	1020	950	800	730	32°	949	884	744	679
		43°	860	780	650	600	43°	800	725	605	558
		109°					109°				

MODELS
MODELOS

Model	Temp.EV (°C)	ASHRAE CONDITIONS (W) (BTu/h)	(W) 43°C	(n.)	(mm²)	FUSE	100 Kg (Kw/h)	(l/h)	HEAT REJECTED (W) (BTu/h)	(Kg)	(Kg)	(m³)
SC 1000	-22	5.500 18.767	2.585	5	2,5	16	7,5	41,6	6.600 22.520	249	353	2,63



ICETECH, S.A.
POL. IND. LA REVA, SECTOR 13, AV. GREMIS, 1
46394 RIBARROJA DE TURIA, VALENCIA, SPAIN
PHONE: +34 961 667 636 FAX: +34 961 668 944
sales@icetechice.com | www.icetechice.com



SERVICE
SERVICIO ASISTENCIA TÉCNICA
sales@icetechice.com
Skype: ICETECH.Service
+34 961 667 639
8:00AM | 7:00PM



Subject to certain limitations and exclusions. Only spare parts.
Sujeto a limitaciones y exclusiones. Solo piezas de repuesto



9001
14001

