

SC 1500





THREE PHASE
400 V / 50 Hz

MODULAR FLAKE ICE MACHINE

FEATURES CARACTERÍSTICAS

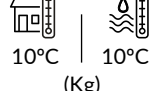
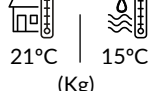
- ▶ **PRODUCES COLD AND DRY FLAT FLAKES. FLAKE THICKNESS MAY BE ADJUSTED BETWEEN 1.5 mm AND 3 mm**
▶ PRODUCE ESCAMAS PLANAS MUY FRÍAS Y SECAS. EL ESPESOR PUEDE REGULARSE ENTRE 1.5 Y 3 mm
- ▶ **BASED ON A STATIC CYLINDER WHICH IS FREE FROM SWIVEL JOINTS (HELICAL REAMER) COUPLED WITH A MILLING TOOL THAT DETACHES THE ICE WITHOUT ANY STRAINED OR FORCED MOVEMENTS**
▶ FUNCIONAMIENTO BASADO EN UN CILINDRO ESTÁTICO SIN JUNTAS GIRATORIAS (HELICAL REAMER) Y CON UNA FRESA QUE DESPEGA EL HIELO SIN TENSIONES NI ESFUERZOS
- ▶ **THE MOST EFFICIENT EVAPORATOR OF THE MARKET, LESS ENERGY CONSUMPTION AND HIGHER ICE PRODUCTION**
▶ EL EVAPORADOR MAS EFICIENTE DEL MERCADO, MENOR GASTO ENERGÉTICO, MAYOR PRODUCCIÓN DE HIELO
- ▶ **ELECTRONIC STOP SYSTEM / ELECTRICAL CONTROL PANEL / DRIVE DIRECT GEAR MOTOR / MAGNETIC DRIVE PUMP / LOW WATER SAFETY DEVICE**
▶ SISTEMA DE PARO ELECTRÓNICO / CUADRO ELÉCTRICO DE REGULACIÓN / MOTORREDUCTOR DE ATAQUE DIRECTO / BOMBA DE ARRASTRE MAGNÉTICO / SEGURIDAD ANTE FALTA DE AGUA
- ▶ **STAINLESS STEEL SOLEPLATE**
▶ BANCADA DE ACERO INOXIDABLE
- ▶ **CONTROLLERS TO DETECT: LOW WATER LEVEL, TEMPERATURE RISE DUE TO MOTOR OVERLOAD OR FULL VAT**
▶ CONTROLES PARA DETECTAR: FALTA DE NIVEL DE AGUA, AUMENTO DE TEMPERATURA POR SOBRESFUERZO EN EL MOTORREDUCTOR O POR LLENADO DE ALMACÉN

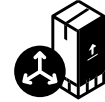

						
SC 1500		1.650	1.500	Width 1.420 Depth 1.645 Height 1.447	Width 1.575 Depth 1.785 Height 1.890	FLAKE ICE -7°C Ice Temperature

ACCESSORIES ACCESORIOS

INCLUDED



WATER INLET FILTER GASKET
JUNTA DE FILTRO DE ENTRADA DE AGUA



WATER INLET HOSE
MANGUERA DE ENTRADA DE AGUA



WATER OUTLET HOSE
MANGUERA DE DESAGÜE

NOT INCLUDED (OPTIONAL)



ICE DROP CHUTE
TUBO DE CAÍDA DE HIELO



SALT DOSING PUMP WITH TANK
BOMBA DOSIFICADORA DE SAL CON DEPÓSITO



REMOTE SWITCH FILTER
INTERRUPTOR REMOTO



REMOTE SWITCH & WEEKLY PROGRAMMER
INTERRUPTOR REMOTO CON PROGRAMADOR SEMANAL



EXTERNAL STOP FULL BIN PHOTO CELL
SENSOR DE PARO EXTERNO POR LLENADO

RECOMMENDED BINS DEPÓSITOS RECOMENDADOS



SS221 + SCALA 1500

SC 1500

RIGHT SIDE VIEW
VISTA LATERAL DERECHA

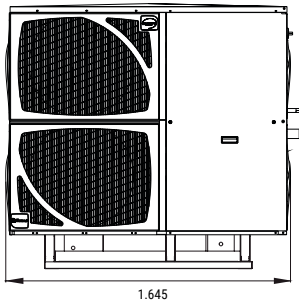

FRONTAL VIEW
VISTA FRONTAL

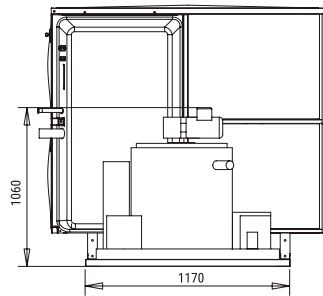

LEFT SIDE VIEW
VISTA LATERAL IZQUIERDA

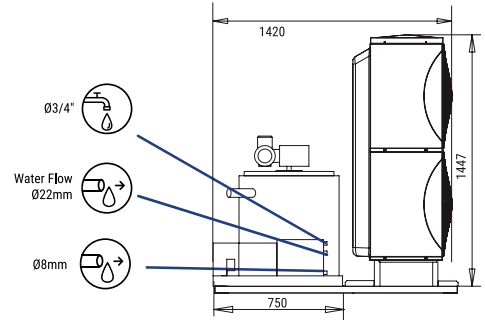

CENTRAL CROSS SECTION VIEW OF THE BASE
VISTA DE LA BASE DESDE SECCIÓN CENTRAL

REAR VIEW
VISTA TRASERA

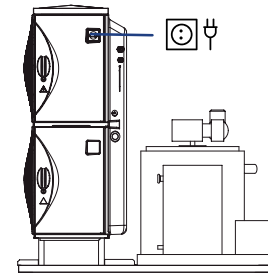
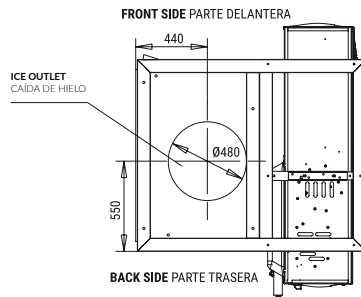

* All measurements in mm.
* Todas las cotas en mm.

OPERATING CONDITIONS CONDICIONES DE OPERACIÓN

PRODUCTION 50Hz PRODUCCIÓN 50 Hz

±10% V 10°C/43°C 5°C/38°C 1 bar/6 bar	R 449 A <table border="1"> <tr> <td>V</td> <td>Hz</td> <td>ph</td> </tr> <tr> <td>400</td> <td>50</td> <td>3N</td> </tr> </table>	V	Hz	ph	400	50	3N	24 H Kg SC 1500 I 1'5"-2'2 mm	<table border="1"> <tr> <th>°C</th> <th>10°</th> <th>15°</th> <th>21°</th> <th>30°</th> </tr> <tr> <th>°F</th> <th>50°</th> <th>60°</th> <th>70°</th> <th>86°</th> </tr> <tr> <td>10°</td> <td>1650</td> <td>1575</td> <td>1350</td> <td>1240</td> </tr> <tr> <td>50°</td> <td></td> <td></td> <td></td> <td></td> </tr> <tr> <td>21°</td> <td>1600</td> <td>1500</td> <td>1290</td> <td>1190</td> </tr> <tr> <td>68°</td> <td></td> <td></td> <td></td> <td></td> </tr> <tr> <td>32°</td> <td>1520</td> <td>1400</td> <td>1200</td> <td>1100</td> </tr> <tr> <td>90°</td> <td></td> <td></td> <td></td> <td></td> </tr> <tr> <td>43°</td> <td>1280</td> <td>1180</td> <td>950</td> <td>900</td> </tr> <tr> <td>109°</td> <td></td> <td></td> <td></td> <td></td> </tr> </table>	°C	10°	15°	21°	30°	°F	50°	60°	70°	86°	10°	1650	1575	1350	1240	50°					21°	1600	1500	1290	1190	68°					32°	1520	1400	1200	1100	90°					43°	1280	1180	950	900	109°					24 H Kg SC 1500 I 3 mm	<table border="1"> <tr> <th>°C</th> <th>10°</th> <th>15°</th> <th>21°</th> <th>30°</th> </tr> <tr> <th>°F</th> <th>50°</th> <th>60°</th> <th>70°</th> <th>86°</th> </tr> <tr> <td>10°</td> <td>1535</td> <td>1465</td> <td>1256</td> <td>1153</td> </tr> <tr> <td>50°</td> <td></td> <td></td> <td></td> <td></td> </tr> <tr> <td>21°</td> <td>1488</td> <td>1395</td> <td>1200</td> <td>1107</td> </tr> <tr> <td>68°</td> <td></td> <td></td> <td></td> <td></td> </tr> <tr> <td>32°</td> <td>1414</td> <td>1302</td> <td>1116</td> <td>1023</td> </tr> <tr> <td>90°</td> <td></td> <td></td> <td></td> <td></td> </tr> <tr> <td>43°</td> <td>1190</td> <td>1097</td> <td>884</td> <td>837</td> </tr> <tr> <td>109°</td> <td></td> <td></td> <td></td> <td></td> </tr> </table>	°C	10°	15°	21°	30°	°F	50°	60°	70°	86°	10°	1535	1465	1256	1153	50°					21°	1488	1395	1200	1107	68°					32°	1414	1302	1116	1023	90°					43°	1190	1097	884	837	109°				
		V	Hz	ph																																																																																																											
400	50	3N																																																																																																													
°C	10°	15°	21°	30°																																																																																																											
°F	50°	60°	70°	86°																																																																																																											
10°	1650	1575	1350	1240																																																																																																											
50°																																																																																																															
21°	1600	1500	1290	1190																																																																																																											
68°																																																																																																															
32°	1520	1400	1200	1100																																																																																																											
90°																																																																																																															
43°	1280	1180	950	900																																																																																																											
109°																																																																																																															
°C	10°	15°	21°	30°																																																																																																											
°F	50°	60°	70°	86°																																																																																																											
10°	1535	1465	1256	1153																																																																																																											
50°																																																																																																															
21°	1488	1395	1200	1107																																																																																																											
68°																																																																																																															
32°	1414	1302	1116	1023																																																																																																											
90°																																																																																																															
43°	1190	1097	884	837																																																																																																											
109°																																																																																																															

MODELS MODELOS	Temp.EV. (°C)	ASHRAE CONDITIONS CONDICIONES ASHRAE (W) (BTu/h)	(W) 43°C	(n.) (mm²)	FUSE	100 Kg (Kw/h)	(l/h)	HEAT REJECTED (W) (BTu/h)	(Kg)	(Kg)	(m³)
SC 1500	-22	8.250 28.150	6.640	5 4	16	10,3	62,5	9.900 33.780	490	550	5,31