



# SC 2000









THREE PHASE  
400 V / 50 Hz

## MODULAR FLAKE ICE MACHINE

### FEATURES CARATTERISTICHE

- ▶ **PRODUCES COLD AND DRY FLAT FLAKES. FLAKE THICKNESS MAY BE ADJUSTED BETWEEN 1.5 mm AND 3 mm.**  
 ▶ PRODUCE SCAGLIE PIANE MOLTO FREDDI E ASCIUTTE. LO SPESSORE È REGOLABILE DA 1.5 A 3 mm.
- ▶ **BASED ON A STATIC CYLINDER WHICH IS FREE FROM SWIVEL JOINTS (HELICAL REAMER) COUPLED WITH A MILLING TOOL THAT DETACHES THE ICE WITHOUT ANY STRAINED OR FORCED MOVEMENTS.**  
 ▶ FUNZIONAMENTO BASATO SU UN CILINDRO STATICO SENZA GIUNTI ROTANTI (ALESATORE ELICOIDALE) E CON UNA FRESA CHE STACCA IL GHIACCIO SENZA TENSIONE O SFORZO.
- ▶ **THE MOST EFFICIENT EVAPORATOR OF THE MARKET, LESS ENERGY CONSUMPTION AND HIGHER ICE PRODUCTION.**  
 ▶ L'EVAPORATORE PIÙ EFFICIENTE SUL MERCATO, CONSUMO ENERGETICO MINORE, MAGGIORE PRODUZIONE DI GHIACCIO.
- ▶ **ELECTRONIC STOP SYSTEM / ELECTRICAL CONTROL PANEL / DRIVE DIRECT GEAR MOTOR / MAGNETIC DRIVE PUMP / LOW WATER SAFETY DEVICE.**  
 ▶ SISTEMA ELETTRONICO DI ARRESTO / PANNELLO DI CONTROLLO ELETTRICO / MOTORIDUTTORE CON TRASMISSIONE DIRETTA / POMPA A TRASCINAMENTO MAGNETICO / DISPOSITIVO DI SICUREZZA IN CASO DI MANCANZA DI ACQUA.
- ▶ **STAINLESS STEEL SOLEPLATE.**  
 ▶ PIASTRA IN ACCIAIO INOSSIDABILE.
- ▶ **CONTROLLERS TO DETECT: LOW WATER LEVEL, TEMPERATURE RISE DUE TO MOTOR OVERLOAD OR FULL VAT.**  
 ▶ DISPOSITIVI PER RILEVARE: MANCANZA DI ACQUA, AUMENTO DELLA TEMPERATURA A CAUSA DEL SOVRACCARICO DEL MOTORE O PER RIEMPIMENTO DELLA VASCHETTA.



	 24 H	 10°C	 10°C	 21°C	 15°C			
		(Kg)	(Kg)	(Kg)	(Kg)	(mm)	(mm)	
SC 2000		2.200	2.000	Width 1.405 Depth 1.613 Height 1.600	Width 1.780 Depth 1.880 Height 1.620	<b>FLAKE ICE</b> -7°C Ice Temperature		

### ACCESSORIES ACCESSORI

#### INCLUDED



**WATER INLET FILTER GASKET**  
GIUNTURA DEL FILTRO DI INGRESSO DELL'ACQUA



**WATER INLET HOSE**  
TUBO INGRESSO DELL'ACQUA



**WATER OUTLET HOSE**  
TUBO DI SCARICO

#### NOT INCLUDED (OPTIONAL)



**ICE DROP CHUTE**  
TUBO DI FUORIUSCITA DEL GHIACCIO



**SALT DOSING PUMP WITH TANK**  
BOMBA DOSATORE DI SALE CON SERBATOIO



**REMOTE SWITCH**  
INTERRUTTORE REMOTO



**REMOTE SWITCH & WEEKLY PROGRAMMER**  
INTERRUTTORE REMOTO CON TIMER SETTIMANALE



**EXTERNAL STOP FULL BIN PHOTO CELL**  
SENSORE DI ARRESTO ESTERNO PER RIEMPIMENTO

### RECOMMENDED BINS SERBATOI RACCOMANDATI



BS221 + SC 1500

SC 2000

**RIGHT SIDE VIEW**  
VISTA LATERALE DESTRA

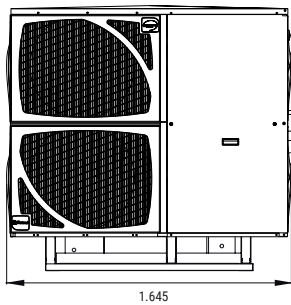

**FRONTAL VIEW**  
VISTA FRONTALE

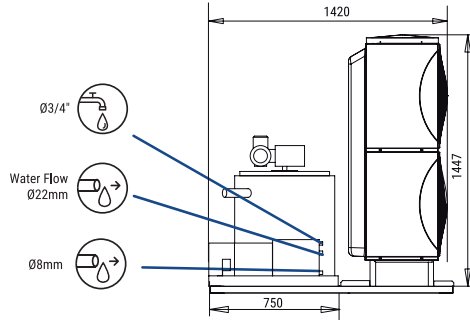

**LEFT SIDE VIEW**  
VISTA LATERALE SINISTRO

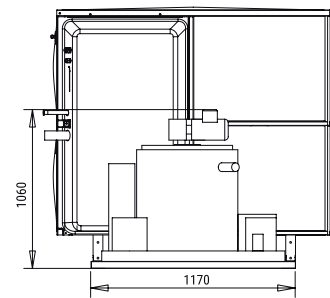

**CENTRAL CROSS SECTION VIEW OF THE BASE**  
VISTA DE LA BASE DESDE SECCIÓN CENTRAL

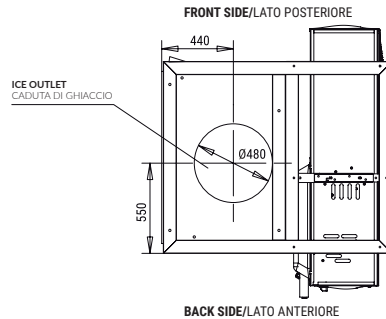

**REAR VIEW**  
VISTA POSTERIORE

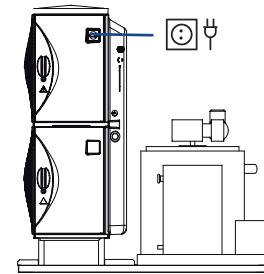

\* All measurements in mm.  
\* Tutte le misure in mm.

**OPERATING CONDITIONS CONDIZIONI PER IL FUNZIONAMENTO**

PRODUCTION 50Hz PRODUZIONE 50 Hz

Icon	Value	SC 2000					SC 2000				
		10°	15°	21°	30°	10°	15°	21°	30°		
±10% V	±10% V	2200	2100	1800	1650	2046	1953	1674	1535		
10°C/43°C	10°C/43°C	2190	2000	1750	1580	2037	1860	1628	1469		
5°C/38°C	5°C/38°C	2050	1900	1600	1450	1907	1767	1488	1349		
1 bar/6 bar	1 bar/6 bar	1750	1580	1300	1200	1628	1469	1209	1116		

MODELS MODELLI	Temp.EV. (°C)	ASHRAE CONDITIONS CONDIZIONI ASHRAE (W) (BTu/h)	(W) 43°C	(n.) (mm²)	FUSE	100 Kg (Kw/h)	(l/h)	HEAT REJECTED (W) (BTu/h)	(Kg)	(Kg)	(m³)
SC 2000	-24	11.000 37.534	7.870	5 4	16	9,2	83,3	13.200 42.040	513	550	5,42



ICETECH, S.A.  
POL. IND. LA REVA, SECTOR 13, AV. GREMIS, 1  
46394 RIBARROJA DE TURIA, VALENCIA, SPAIN  
PHONE: +34 961 667 636 FAX: +34 961 668 944  
sales@icetechice.com | www.icetechice.com



SERVICE  
SERVIZIO ASSISTENZA TECNICA  
sales@icetechice.com  
Skype: ICETECH.Service  
+34 961 667 639  
8:00AM | 7:00PM



Subject to certain limitations and exclusions. Only spare parts.  
Soggetta a limitazioni e revoca.  
Solo parti di ricambio.



9001  
14001

