



SC 600







THREE PHASE
400 V / 50 Hz

MODULAR FLAKE ICE MACHINE

FEATURES CARACTERÍSTICAS

- ▶ **PRODUCES COLD AND DRY FLAT FLAKES. FLAKE THICKNESS MAY BE ADJUSTED BETWEEN 1.5 mm AND 3 mm**
PRODUCE ESCAMAS PLANAS MUY FRÍAS Y SECAS. EL ESPESOR PUEDE REGULARSE ENTRE 1.5 Y 3 mm
- ▶ **BASED ON A STATIC CYLINDER WHICH IS FREE FROM SWIVEL JOINTS (HELICAL REAMER) COUPLED WITH A MILLING TOOL THAT DETACHES THE ICE WITHOUT ANY STRAINED OR FORCED MOVEMENTS**
FUNCIONAMIENTO BASADO EN UN CILINDRO ESTÁTICO SIN JUNTAS GIRATORIAS (HELICAL REAMER) Y CON UNA FRESA QUE DESPEGA EL HIELO SIN TENSIONES NI ESFUERZOS
- ▶ **THE MOST EFFICIENT EVAPORATOR OF THE MARKET, LESS ENERGY CONSUMPTION AND HIGHER ICE PRODUCTION**
EL EVAPORADOR MAS EFICIENTE DEL MERCADO, MENOR GASTO ENERGÉTICO, MAYOR PRODUCCIÓN DE HIELO
- ▶ **ELECTRONIC STOP SYSTEM / ELECTRICAL CONTROL PANEL / DRIVE DIRECT GEAR MOTOR / MAGNETIC DRIVE PUMP / LOW WATER SAFETY DEVICE**
SISTEMA DE PARO ELECTRÓNICO / CUADRO ELÉCTRICO DE REGULACIÓN / MOTORREDUCTOR DE ATAQUE DIRECTO / BOMBA DE ARRASTRE MAGNÉTICO / SEGURIDAD ANTE FALTA DE AGUA
- ▶ **STAINLESS STEEL SOLEPLATE**
BANCADA DE ACERO INOXIDABLE
- ▶ **CONTROLLERS TO DETECT: LOW WATER LEVEL, TEMPERATURE RISE DUE TO MOTOR OVERLOAD OR FULL VAT**
CONTROLES PARA DETECTAR: FALTA DE NIVEL DE AGUA, AUMENTO DE TEMPERATURA POR SOBRESFUERZO EN EL MOTORREDUCTOR O POR LLENADO DE ALMACÉN



	 24 H	 10°C	 15°C	 (mm)	 (mm)	
SC 600		675	600	Width 1.255 Depth 755 Height 835	Width 1.350 Depth 855 Height 960	FLAKE ICE -7°C Ice Temperature

ACCESSORIES ACCESORIOS

INCLUDED



WATER INLET FILTER GASKET
JUNTA DE FILTRO DE ENTRADA DE AGUA



WATER INLET HOSE
MANGUERA DE ENTRADA DE AGUA



WATER OUTLET HOSE
MANGUERA DE DESAGÜE

NOT INCLUDED (OPTIONAL)



ICE DROP CHUTE
TUBO DE CAÍDA DE HIELO



SALT DOSING PUMP WITH TANK
BOMBA DOSIFICADORA DE SAL CON DEPÓSITO



REMOTE SWITCH
INTERRUPTOR REMOTO



REMOTE SWITCH & WEEKLY PROGRAMMER
INTERRUPTOR REMOTO CON PROGRAMADOR SEMANAL



EXTERNAL STOP FULL BIN PHOTO CELL
SENSOR DE PARO EXTERNO POR LLENADO

RECOMMENDED BINS DEPÓSITOS RECOMENDADOS



B500 + SC 600



BCD400 + SC 600



BCD600 + SC 600



BCD800 + SC 600

SC 600

RIGHT SIDE VIEW
VISTA LATERAL DERECHA

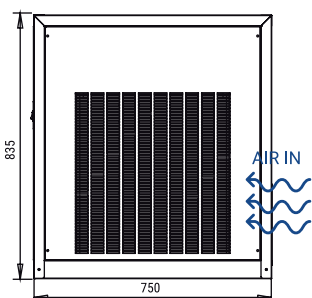

FRONTAL VIEW
VISTA FRONTAL

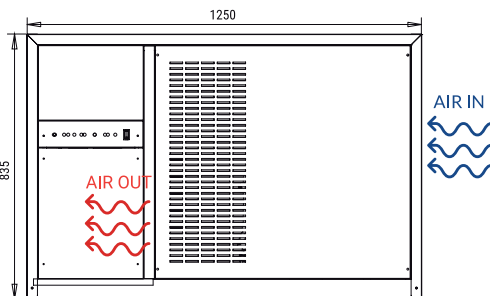

LEFT SIDE VIEW
VISTA LATERAL IZQUIERDA

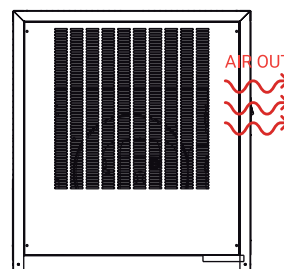

CENTRAL CROSS SECTION VIEW OF THE BASE
VISTA DE LA BASE DESDE SECCIÓN CENTRAL

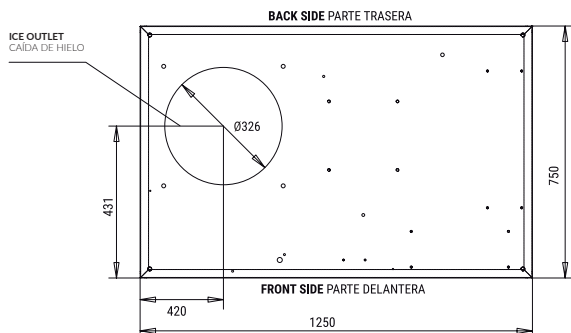

REAR VIEW
VISTA TRASERA

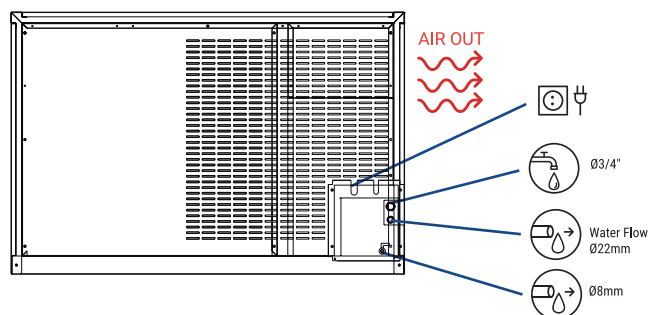

* All measurements in mm.
* Todas las cotas en mm.

OPERATING CONDITIONS CONDICIONES DE OPERACIÓN

PRODUCTION 50Hz PRODUCCIÓN 50 Hz

±10% V

10°C/43°C

5°C/38°C

1 bar/6 bar



V	Hz	ph
400	50	3N

SC 600

°C / °F	10° / 50°	15° / 60°	21° / 70°	30° / 86°
10° / 50°	675	630	525	465
21° / 68°	660	600	502	435
32° / 90°	615	540	450	390
43° / 109°	502	435	345	300

SC 600

°C / °F	10° / 50°	15° / 60°	21° / 70°	30° / 86°
10° / 50°	628	586	488	432
21° / 68°	614	558	467	405
32° / 90°	572	502	419	363
43° / 109°	467	405	321	279

MODELS
MODELOS

SC 600

Temp.EV. (°C)	ASHRAE CONDITIONS (W) (BTu/h)	(W) 43°C	(n.) (mm²)	FUSE	100 Kg (Kw/h)	(l/h)	HEAT REJECTED (W) (BTu/h)	(Kg)	(Kg)	(m³)
-22	3.300 11.260	2.350	5 2,5	16	6,12	25	3.960 13.512	197	227	1,10



ICETECH, S.A.
POL. IND. LA REVA, SECTOR 13, AV. GREMIS, 1
46394 RIBARROJA DE TURIA, VALENCIA, SPAIN
PHONE: +34 961 667 636 FAX: +34 961 668 944
sales@icetechice.com | www.icetechice.com



SERVICE
SERVICIO ASISTENCIA TÉCNICA
sales@icetechice.com
Skype: ICETECH.Service
+34 961 667 639
8:00AM | 7:00PM



Subject to certain limitations and exclusions. Only spare parts.
Sujeto a limitaciones y exclusiones. Solo piezas de repuesto



9001
14001

