



SC 2000 REMOTE









THREE PHASE
400 V / 50 Hz

MODULAR FLAKE ICE MACHINE WITH REMOTE UNIT

FEATURES CARACTERÍSTICAS

- ▶ **PRODUCES COLD AND DRY FLAT FLAKES. FLAKE THICKNESS MAY BE ADJUSTED BETWEEN 1.5 mm AND 3 mm**
PRODUCE ESCAMAS PLANAS MUY FRÍAS Y SECAS. EL ESPESOR PUEDE REGULARSE ENTRE 1.5 Y 3 mm
- ▶ **BASED ON A STATIC CYLINDER WHICH IS FREE FROM SWIVEL JOINTS (HELICAL REAMER) COUPLED WITH A MILLING TOOL THAT DETACHES THE ICE WITHOUT ANY STRAINED OR FORCED MOVEMENTS**
FUNCIONAMIENTO BASADO EN UN CILINDRO ESTÁTICO SIN JUNTAS GIRATORIAS (HELICAL REAMER) Y CON UNA FRESA QUE DESPEGA EL HIELO SIN TENSIONES NI ESFUERZOS
- ▶ **THE MOST EFFICIENT EVAPORATOR OF THE MARKET, LESS ENERGY CONSUMPTION AND HIGHER ICE PRODUCTION**
EL EVAPORADOR MAS EFICIENTE DEL MERCADO, MENOR GASTO ENERGÉTICO, MAYOR PRODUCCIÓN DE HIELO
- ▶ **ELECTRONIC STOP SYSTEM / ELECTRICAL CONTROL PANEL / DRIVE DIRECT GEAR MOTOR / MAGNETIC DRIVE PUMP / LOW WATER SAFETY DEVICE**
SISTEMA DE PARO ELECTRÓNICO / CUADRO ELÉCTRICO DE REGULACIÓN / MOTORREDUCTOR DE ATAQUE DIRECTO / BOMBA DE ARRASTRE MAGNÉTICO / SEGURIDAD ANTE FALTA DE AGUA
- ▶ **STAINLESS STEEL SOLEPLATE**
BANCADA DE ACERO INOXIDABLE
- ▶ **CONTROLLERS TO DETECT: LOW WATER LEVEL, TEMPERATURE RISE DUE TO MOTOR OVERLOAD OR FULL VAT**
CONTROLES PARA DETECTAR: FALTA DE NIVEL DE AGUA, AUMENTO DE TEMPERATURA POR SOBRESFUERZO EN EL MOTORREDUCTOR O POR LLENADO DE ALMACÉN



	 24 H	 10°C	 10°C	 21°C	 15°C		
	(Kg)	(Kg)	(Kg)	(Kg)	(Kg)	(mm)	(mm)
SC 2000 SPLIT		2.200	2.000	Width 1.050 Depth 750 Height 1.060	Width 1.150 Depth 850 Height 1.190		
RCU 2000	-	-	Width 1.613 Depth 574 Height 1.297	Width 1.780 Depth 730 Height 1.620			 FLAKE ICE -7°C Ice Temperature

ACCESSORIES ACCESORIOS

INCLUDED



WATER INLET FILTER GASKET
JUNTA DE FILTRO DE ENTRADA DE AGUA



WATER INLET HOSE
MANGUERA DE ENTRADA DE AGUA



WATER OUTLET HOSE
MANGUERA DE DESAGÜE

NOT INCLUDED (OPTIONAL)



ICE DROP CHUTE
TUBO DE CAÍDA DE HIELO



SALT DOSING PUMP WITH TANK
BOMBA DOSIFICADORA DE SAL CON DEPÓSITO



REMOTE SWITCH FILTER
INTERRUPTOR REMOTO



REMOTE SWITCH & WEEKLY PROGRAMMER
INTERRUPTOR REMOTO CON PROGRAMADOR SEMANAL



EXTERNAL STOP FULL BIN PHOTO CELL
SENSOR DE PARO EXTERNO POR LLENADO

RECOMMENDED BINS DEPÓSITOS RECOMENDADOS



B500 + SC 2000 SPLIT



BCD400 + SC 2000 SPLIT



BCD600 + SC 2000 SPLIT



BCD800 + SC 2000 SPLIT



BS221 + SC 2000 SPLIT

SC 2000 SPLIT

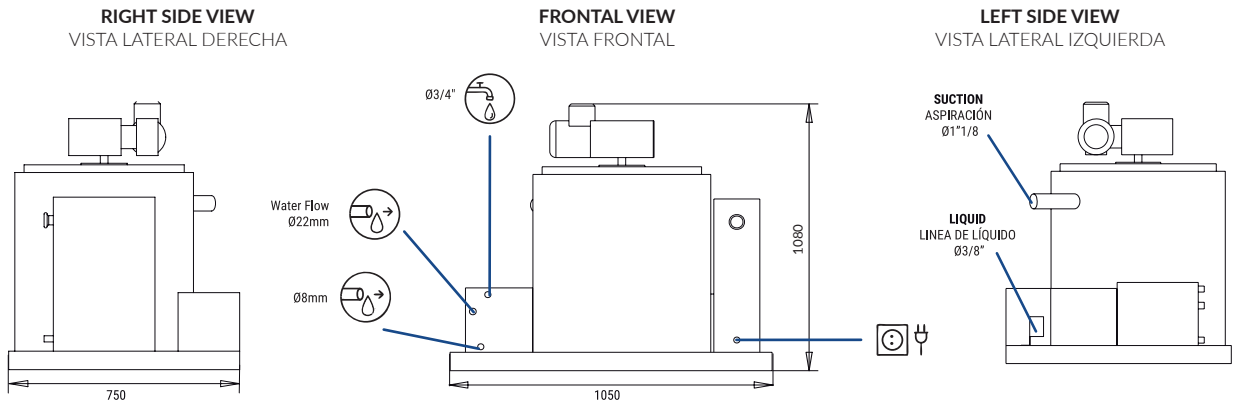

RCU 2000

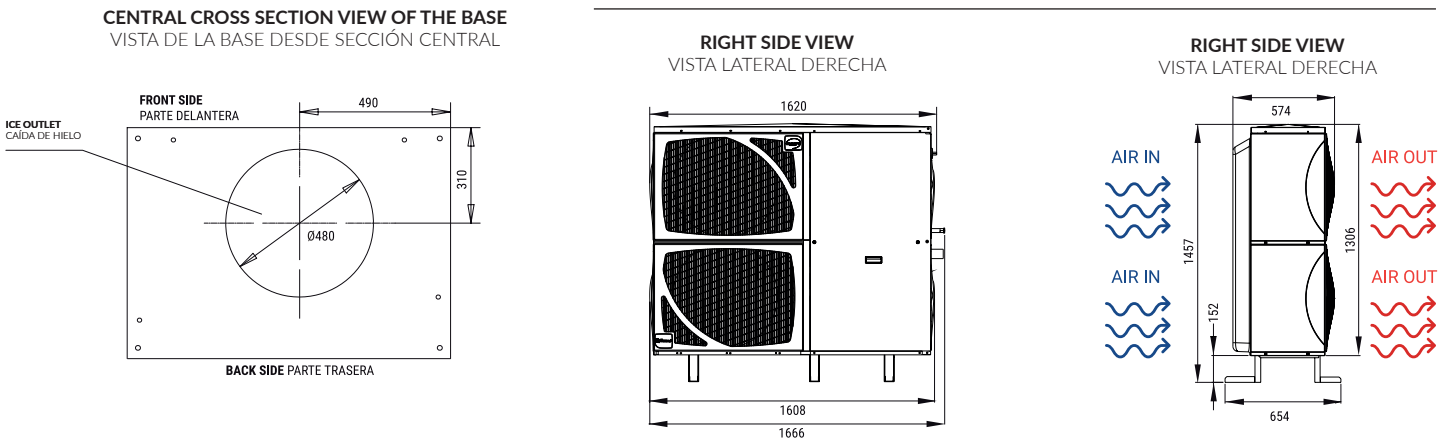

* All measurements in mm.
* Todas las cotas en mm.

OPERATING CONDITIONS CONDICIONES DE OPERACIÓN

PRODUCTION 50Hz PRODUCCIÓN 50 Hz

Icon	Value	SC 2000 REMOTE (1'5-2'2 mm)				SC 2000 REMOTE (3 mm)			
		10°	15°	21°	30°	10°	15°	21°	30°
±10% V	±10% V								
10°C/43°C	10°C/43°C	2200	2100	1800	1650	2046	1953	1674	1535
5°C/38°C	5°C/38°C	2190	2000	1750	1580	2037	1860	1628	1469
1 bar/6 bar	1 bar/6 bar	2050	1900	1600	1450	1907	1767	1488	1349
		1750	1580	1300	1200	1628	1469	1209	1116

MODELS
MODELOS

Model	Temp. EV (°C)	ASHRAE CONDITIONS (W) (BTU/h)	(W) 43°C	(n.) (mm ²)	FUSE	100 Kg (Kw/h)	(l/h)	HEAT REJECTED (W) (BTU/h)	(Kg)	(Kg)	(m ³)
SC 2000 S	-22	11.000 37.534	200	3 4	16	9,3	83,3	- -	230	290	1,16
RCU 2000	-	- -	7.670	5 4	16	-	-	13.200 45.040	263	328	2,10