









# SC 15000 SPLIT 230 V / 50-60 Hz

## MODULAR FLAKE ICE MACHINE SPLIT

### FEATURES CARATTERISTICHE

- ▶ **PRODUCES COLD AND DRY FLAT FLAKES. FLAKE THICKNESS MAY BE ADJUSTED BETWEEN 1.5 mm AND 3 mm.**  
PRODUCE SCAGLIE PIANE MOLTO FREDDI E ASCIUTTE. LO SPESSORE È REGOLABILE DA 1.5 A 3 mm.
- ▶ **BASED ON A STATIC CYLINDER WHICH IS FREE FROM SWIVEL JOINTS (HELICAL REAMER) COUPLED WITH A MILLING TOOL THAT DETACHES THE ICE WITHOUT ANY STRAINED OR FORCED MOVEMENTS.**  
FUNZIONAMENTO BASATO SU UN CILINDRO STATICO SENZA GIUNTI ROTANTI (ALESATORE ELICOIDALE) E CON UNA FRESA CHE STACCA IL GHIACCIO SENZA TENSIONE O SFORZO.
- ▶ **THE MOST EFFICIENT EVAPORATOR OF THE MARKET, LESS ENERGY CONSUMPTION AND HIGHER ICE PRODUCTION.**  
L'EVAPORATORE PIÙ EFFICIENTE SUL MERCATO, CONSUMO ENERGETICO MINORE, MAGGIORE PRODUZIONE DI GHIACCIO.
- ▶ **THERMOSTATIC EXPANSION VALVE / LIQUID SOLENOID VALVE / STOP WHEN FULL BIN STOP WITH PHOTOELECTRICAL SENSOR**  
VALVOLA DI ESPANSIONE TERMOSTATICA / VALVOLA A SOLENOIDE DEL LIQUIDO / RRESTO PER RIEMPIMENTO DELLA CISTERNA CON SENSORE FOTOELETRICO
- ▶ **ELECTRONIC STOP SYSTEM / ELECTRICAL CONTROL PANEL / DRIVE DIRECT GEAR MOTOR / MAGNETIC DRIVE PUMP / LOW WATER SAFETY DEVICE.**  
SISTEMA ELETTRONICO DI ARRESTO / PANNELLO DI CONTROLLO ELETTRICO / MOTORIDUTTORE CON TRASMISSIONE DIRETTA / POMPA A TRASCINAMENTO MAGNETICO / DISPOSITIVO DI SICUREZZA IN CASO DI MANCANZA DI ACQUA.
- ▶ **STAINLESS STEEL SOLEPLATE.**  
PIASTRA IN ACCIAIO INOSSIDABILE.
- ▶ **CONTROLLERS TO DETECT: LOW WATER LEVEL, TEMPERATURE RISE DUE TO MOTOR OVERLOAD OR FULL VAT.**  
DISPOSITIVI PER RILEVARE: MANCANZA DI ACQUA, AUMENTO DELLA TEMPERATURA A CAUSA DEL SOVRACCARICO DEL MOTORE O PER RIEMPIMENTO DELLA VASCHETTA.



	 24 H	 10°C (Kg)	 15°C (Kg)	 (mm)	 (mm)	
SC 15000 SPLIT		16.500	15.000	Width 2.200 Depth 1.520 Height 2.100	Width 2.260 Depth 1.585 Height 2.170	<b>FLAKE ICE</b> -7°C Ice Temperature

### ACCESSORIES ACCESSORI

NOT INCLUDED (OPTIONAL)



SALT DOSING PUMP WITH TANK  
BOMBA DOSATORE DI SALE CON SERBATOIO



REMOTE SWITCH  
INTERRUPTOR REMOTO



REMOTE SWITCH & WEEKLY PROGRAMMER  
INTERRUPTORE REMOTO CON TIMER SETTIMANALE



EXTERNAL STOP FULL BIN PHOTO CELL  
SENSORE DI ARRESTO ESTERNO PER RIEMPIMENTO

### RECOMMENDED BINS SERBATOI RACCOMANDATI



BS422 + SC 15000 SPLIT



BS623 + SC 15000 SPLIT



BS732 + SC 15000 SPLIT



BS1132 + SC 15000 SPLIT

SC 15000 SPLIT

**RIGHT SIDE VIEW**  
VISTA LATERALE DESTRA

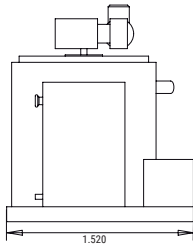

**FRONTAL VIEW**  
VISTA FRONTALE

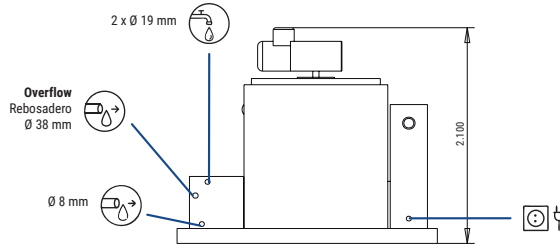

**LEFT SIDE VIEW**  
VISTA LATERALE SINISTRO

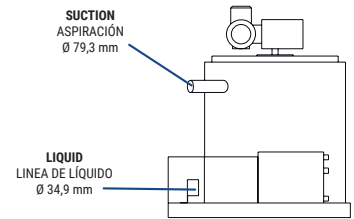

**CENTRAL CROSS SECTION VIEW OF THE BASE**  
VISTA DELLA BASE DALLA ZONA CENTRALE

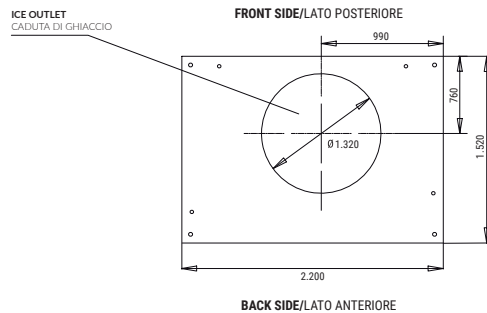

\* All measurements in mm.  
\* Tutte le misure in mm.

**OPERATING CONDITIONS CONDIZIONI PER IL FUNZIONAMENTO**

**PRODUCTION 50-60Hz PRODUZIONE 50-60 Hz**

Icon	Value	SC 15000 SPLIT					SC 15000 SPLIT				
		10°	15°	21°	30°	10°	15°	21°	30°		
±10% V											
10°C/43°C		16500	15500	13400	12300	15345	14415	12462	11439		
5°C/38°C		16200	15000	13000	11900	15066	13950	12090	11067		
1 bar/6 bar		15300	13000	12000	11000	14229	12090	11160	10230		
		13000	11900	9750	9000	12090	11066	9068	8370		

MODELS MODELLI	Temp.EV (°C)	ASHRAE CONDITIONS (W) (BTU/h)	(W) 43°C	(n.) (mm²)	FUSE	100 Kg (Kw/h)	(l/h)	HEAT REJECTED (W) (BTU/h)	(Kg)	(Kg)	(m³)
SC 15000 S	-22	82.500 281.501	1000	3 1,5	16	-*	625	- -	1.500	1.900	7,77

\* WHEN INDICATED COOL REQUIREMENT IS SUPPLIED / QUANDO VIENE FORNITA LA POTENZA FRIGORIFERA RICHIESTA.

0000\_ict/emt\_21/E/21



ICETECH, S.A.  
POL. IND. LA REVA, SECTOR 13, AV. GREMIS, 1  
46394 RIBARROJA DE TURIA, VALENCIA, SPAIN  
PHONE: +34 961 667 636 | FAX: +34 961 668 944  
sales@icetechice.com | www.icetechice.com



SERVICE SERVIZIO ASSISTENZA TECNICA  
sales@icetechice.com  
Skype: ICETECH.Service  
+34 961 667 639  
8:00AM | 7:00PM



Subject to certain limitations and exclusions. Only spare parts.  
Soggetta a limitazioni e revoca. Solo parti di ricambio.



9001 14001

