









SC 3000 SPLIT 230 V / 50-60 Hz

MODULAR FLAKE ICE MACHINE SPLIT

FEATURES CARACTERÍSTICAS

- ▶ **PRODUCES COLD AND DRY FLAT FLAKES. FLAKE THICKNESS MAY BE ADJUSTED BETWEEN 1.5 mm AND 3 mm**
PRODUCE ESCAMAS PLANAS MUY FRÍAS Y SECAS. EL ESPESOR PUEDE REGULARSE ENTRE 1.5 Y 3 mm
- ▶ **BASED ON A STATIC CYLINDER WHICH IS FREE FROM SWIVEL JOINTS (HELICAL REAMER) COUPLED WITH A MILLING TOOL THAT DETACHES THE ICE WITHOUT ANY STRAINED OR FORCED MOVEMENTS**
FUNCIONAMIENTO BASADO EN UN CILINDRO ESTÁTICO SIN JUNTAS GIRATORIAS (HELICAL REAMER) Y CON UNA FRESA QUE DESPEGA EL HIELO SIN TENSIONES NI ESFUERZOS
- ▶ **THE MOST EFFICIENT EVAPORATOR OF THE MARKET, LESS ENERGY CONSUMPTION AND HIGHER ICE PRODUCTION**
EL EVAPORADOR MAS EFICIENTE DEL MERCADO, MENOR GASTO ENERGÉTICO, MAYOR PRODUCCIÓN DE HIELO
- ▶ **THERMOSTATIC EXPANSION VALVE / LIQUID SOLENOID VALVE / STOP WHEN FULL BIN STOP WITH PHOTOELECTRICAL SENSOR**
VÁLVULA DE EXPANSIÓN TERMOSTÁTICA / VÁLVULA SOLENOIDE DE LÍQUIDO / PARO POR LLENADO DE CUBA CON CÉLULA FOTOELÉCTRICA
- ▶ **ELECTRONIC STOP SYSTEM / ELECTRICAL CONTROL PANEL / DRIVE DIRECT GEAR MOTOR / MAGNETIC DRIVE PUMP / LOW WATER SAFETY DEVICE**
SISTEMA DE PARO ELECTRÓNICO / CUADRO ELÉCTRICO DE REGULACIÓN / MOTORREDUCTOR DE ATAQUE DIRECTO / BOMBA DE ARRASTRE MAGNÉTICO / SEGURIDAD ANTE FALTA DE AGUA
- ▶ **STAINLESS STEEL SOLEPLATE**
BANCADA DE ACERO INOXIDABLE
- ▶ **CONTROLLERS TO DETECT: LOW WATER LEVEL, TEMPERATURE RISE DUE TO MOTOR OVERLOAD OR FULL VAT**
CONTROLES PARA DETECTAR: FALTA DE NIVEL DE AGUA, AUMENTO DE TEMPERATURA POR SOBRESFUERZO EN EL MOTORREDUCTOR O POR LLENADO DE ALMACÉN



	 24 H	 10°C	 15°C	 (mm)	 (mm)	
SC 3000 SPLIT		3.300 (Kg)	3.000 (Kg)	Width 1.050 Depth 750 Height 1.150	Width 1.150 Depth 860 Height 1.345	FLAKE ICE -7°C Ice Temperature

ACCESSORIES ACCESORIOS

INCLUDED



WATER INLET FILTER GASKET
JUNTA DE FILTRO DE ENTRADA DE AGUA



WATER INLET HOSE
MANGUERA DE ENTRADA DE AGUA



WATER OUTLET HOSE
MANGUERA DE DESAGÜE

NOT INCLUDED (OPTIONAL)



ICE DROP CHUTE
TUBO DE CAÍDA DE HIELO



SALT DOSING PUMP WITH TANK
BOMBA DOSIFICADORA DE SAL CON DEPÓSITO



REMOTE SWITCH FILTER
INTERRUPTOR REMOTO



REMOTE SWITCH & WEEKLY PROGRAMMER
INTERRUPTOR REMOTO CON PROGRAMADOR SEMANAL



EXTERNAL STOP FULL BIN PHOTO CELL
SENSOR DE PARO EXTERNO POR LLENADO



Y EXTENSION INOX
EXTENSIÓN Y INOX

RECOMMENDED BINS DEPÓSITOS RECOMENDADOS



B500 + SC 3000 SPLIT



BCD400 + SC 3000 SPLIT



BCD600 + SC 3000 SPLIT



BCD800 + SC 3000 SPLIT



BS221 + SC 3000 SPLIT



BS422 + SC 3000 SPLIT

SC 3000 SPLIT

RIGHT SIDE VIEW
VISTA LATERAL DERECHA

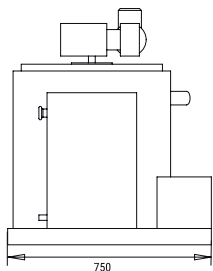

FRONTAL VIEW
VISTA FRONTAL

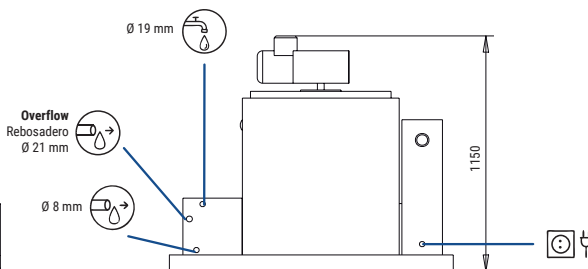

LEFT SIDE VIEW
VISTA LATERAL IZQUIERDA

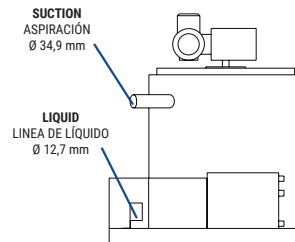

CENTRAL CROSS SECTION VIEW OF THE BASE
VISTA DE LA BASE DESDE SECCIÓN CENTRAL

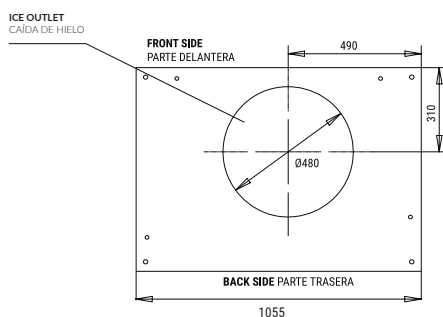

* All measurements in mm.
* Todas las cotas en mm.

OPERATING CONDITIONS CONDICIONES DE OPERACIÓN

PRODUCTION 50-60Hz PRODUCCIÓN 50-60 Hz

±10% V

10°C/43°C

5°C/38°C

1 bar/6 bar

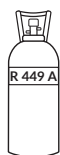

V	Hz	ph
230	50-60	1N

Kg 24 H	SC 3000 SPLIT				
	10° 50°	15° 60°	21° 70°	30° 86°	
10°	3300	3100	2700	2500	
50°	3270	3000	2600	2370	
21°	3100	2800	2400	2150	
68°	2550	2370	1950	1800	
90°					
43°					
109°					

Kg 24 H	SC 3000 SPLIT				
	10° 50°	15° 60°	21° 70°	30° 86°	
10°	3069	2883	2511	2325	
50°	3041	2790	2418	2204	
21°	2883	2604	2232	2000	
68°	2372	2204	1814	1674	
90°					
43°					
109°					

MODELS
MODELOS

SC 3000 S

Temp.EV. (°C)	ASHRAE CONDITIONS CONDICIONES ASHRAE (W) (BTu/h)	(W) 43°C	(n.) (mm²)	FUSE	100 Kg (Kw/h)	(l/h)	HEAT REJECTED (W) (BTu/h)	(Kg)	(Kg)	(m³)
-22	16.500 56.300	200	3 6	16	7,8	126	- -	280	320	1,49

* WHEN INDICATED COOL REQUIREMENT IS SUPPLIED / CUANDO SE SUMINISTRA LA POTENCIA FRIGORÍFICA REQUERIDA



ICETECH, S.A.
POL. IND. LA REVA, SECTOR 13, AV. GREMIS, 1
46394 RIBARROJA DE TURIA, VALENCIA, SPAIN
PHONE: +34 961 667 636 FAX: +34 961 668 944
sales@icetechice.com | www.icetechice.com



SERVICE
SERVICIO ASISTENCIA TÉCNICA
sales@icetechice.com
Skype: ICETECH.Service
+34 961 667 639
8:00AM | 7:00PM



Subject to certain limitations
and exclusions. Only spare parts.
Sujeto a limitaciones y exclusiones.
Solo piezas de repuesto

