









# SC 3000 SPLIT 230 V / 50-60 Hz

## MODULAR FLAKE ICE MACHINE SPLIT

### FEATURES CARATTERISTICHE

- ▶ **PRODUCES COLD AND DRY FLAT FLAKES. FLAKE THICKNESS MAY BE ADJUSTED BETWEEN 1.5 mm AND 3 mm.**  
 ▶ PRODUCE SCAGLIE PIANE MOLTO FREDDHE E ASCIUTTE. LO SPESSORE È REGOLABILE DA 1.5 A 3 mm.
- ▶ **BASED ON A STATIC CYLINDER WHICH IS FREE FROM SWIVEL JOINTS (HELICAL REAMER) COUPLED WITH A MILLING TOOL THAT DETACHES THE ICE WITHOUT ANY STRAINED OR FORCED MOVEMENTS.**  
 ▶ FUNZIONAMENTO BASATO SU UN CILINDRO STATICO SENZA GIUNTI ROTANTI (ALESATORE ELICOIDALE) E CON UNA FRESA CHE STACCA IL GHIACCIO SENZA TENSIONE O SFORZO.
- ▶ **THE MOST EFFICIENT EVAPORATOR OF THE MARKET, LESS ENERGY CONSUMPTION AND HIGHER ICE PRODUCTION.**  
 ▶ L'EVAPORATORE PIÙ EFFICIENTE SUL MERCATO, CONSUMO ENERGETICO MINORE, MAGGIORE PRODUZIONE DI GHIACCIO.
- ▶ **ELECTRONIC STOP SYSTEM / ELECTRICAL CONTROL PANEL / DRIVE DIRECT GEAR MOTOR / MAGNETIC DRIVE PUMP / LOW WATER SAFETY DEVICE.**  
 ▶ SISTEMA ELETTRONICO DI ARRESTO / PANNELLO DI CONTROLLO ELETTRICO / MOTORIDUTTORE CON TRASMISSIONE DIRETTA / POMPA A TRASCINAMENTO MAGNETICO / DISPOSITIVO DI SICUREZZA IN CASO DI MANCANZA DI ACQUA.
- ▶ **STAINLESS STEEL SOLEPLATE.**  
 ▶ PIASTRA IN ACCIAIO INOSSIDABILE.
- ▶ **CONTROLLERS TO DETECT: LOW WATER LEVEL, TEMPERATURE RISE DUE TO MOTOR OVERLOAD OR FULL VAT.**  
 ▶ DISPOSITIVI PER RILEVARE: MANCANZA DI ACQUA, AUMENTO DELLA TEMPERATURA A CAUSA DEL SOVRACCARICO DEL MOTORE O PER RIEMPIMENTO DELLA VASCHETTA.
- ▶ **ELECTRONIC EXPANSION VALVE / SUCTION REGULATING VALVE / STOP WHEN FULL BIN STOP WITH PHOTOELECTRICAL SENSOR.**  
 ▶ VALVOLA AD ESPANSIONE ELETTRONICA / VALVOLA DI REGOLAZIONE DELL'ASPIRAZIONE / ARRESTO PER RIEMPIMENTO DELLA VASCHETTA CON CELLULA FOTOELETTRICA.



	 24 H	 10°C	 15°C	 (mm)	 (mm)	
SC 3000 SPLIT		3.300 (Kg)	3.000 (Kg)	Width 1.050 Depth 750 Height 1.150	Width 1.150 Depth 860 Height 1.345	<b>FLAKE ICE</b> -7°C Ice Temperature

### ACCESSORIES ACCESSORI

#### INCLUDED



#### NOT INCLUDED (OPTIONAL)



### RECOMMENDED BINS SERBATOI RACCOMANDATI



SC 3000 SPLIT

**RIGHT SIDE VIEW**  
VISTA LATERALE DESTRA

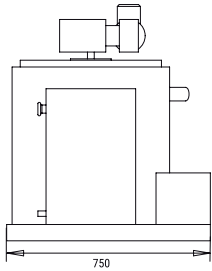

**FRONTAL VIEW**  
VISTA FRONTALE

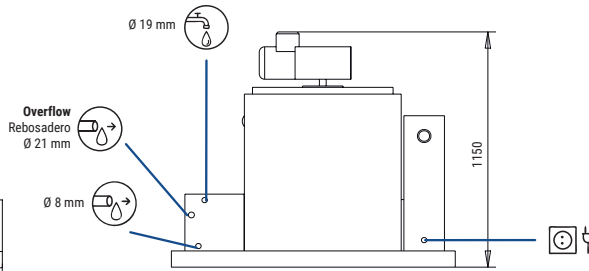

**LEFT SIDE VIEW**  
VISTA LATERALE SINISTRO

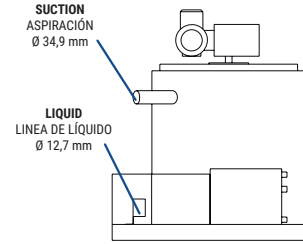

**CENTRAL CROSS SECTION VIEW OF THE BASE**  
VISTA DELLA BASE DALLA ZONA CENTRALE

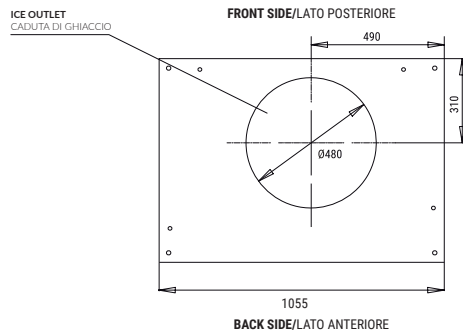

\* All measurements in mm.  
\* Tutte le misure in mm.

**OPERATING CONDITIONS CONDIZIONI PER IL FUNZIONAMENTO**

PRODUCTION 50-60Hz PRODUZIONE 50-60 Hz

Icon	Value	SC 3000 SPLIT					SC 3000 SPLIT				
		10°	15°	21°	30°	10°	15°	21°	30°		
⚡ ±10% V											
🏠 10°C/43°C											
🔥 5°C/38°C											
💧 1 bar/6 bar											
📦											
📦											
📦											
📦											
📦											

MODELS MODELLI	Temp.EV. (°C)	ASHRAE CONDITIONS CONDIZIONI ASHRAE (W) (BTu/h)	(W) 43°C	(n.) (mm²)	FUSE	100 Kg (Kw/h)	(l/h)	HEAT REJECTED (W) (BTu/h)	(Kg)	(Kg)	(m³)
SC 3000 S	-22	16.500 56.300	200	3 6	16	7,8	126	- -	280	320	1,49

\* WHEN INDICATED COOL REQUIREMENT IS SUPPLIED / QUANDO VIENE FORNITA LA POTENZA FRIGORIFERA RICHIESTA.

0000\_ict/emt\_21/E/21



ICETECH, S.A.  
POL. IND. LA REVA, SECTOR 13, AV. GREMIS, 1  
46394 RIBARROJA DE TURIA, VALENCIA, SPAIN  
PHONE: +34 961 667 636 FAX: +34 961 668 944  
sales@icetechice.com | www.icetechice.com



SERVICE  
SERVIZIO ASSISTENZA TECNICA  
sales@icetechice.com  
Skype: ICETECH.Service  
+34 961 667 639  
8:00AM | 7:00PM



Subject to certain limitations and exclusions. Only spare parts.  
Soggetta a limitazioni e revoca.  
Solo parti di ricambio.



9001  
14001

