











SC 400 SPLIT 230 V / 50-60 Hz

MODULAR FLAKE ICE MACHINE SPLIT

FEATURES CARACTERÍSTICAS

- ▶ PRODUCES COLD AND DRY FLAT FLAKES. FLAKE THICKNESS MAY BE ADJUSTED BETWEEN 1.5 mm AND 3 mm
PRODUCE ESCAMAS PLANAS MUY FRÍAS Y SECAS. EL ESPESOR PUEDE REGULARSE ENTRE 1.5 Y 3 mm
- ▶ BASED ON A STATIC CYLINDER WHICH IS FREE FROM SWIVEL JOINTS (HELICAL REAMER) COUPLED WITH A MILLING TOOL THAT DETACHES THE ICE WITHOUT ANY STRAINED OR FORCED MOVEMENTS
FUNCIONAMIENTO BASADO EN UN CILINDRO ESTÁTICO SIN JUNTAS GIRATORIAS (HELICAL REAMER) Y CON UNA FRESA QUE DESPEGA EL HIELO SIN TENSIONES NI ESFUERZOS
- ▶ THE MOST EFFICIENT EVAPORATOR OF THE MARKET, LESS ENERGY CONSUMPTION AND HIGHER ICE PRODUCTION
EL EVAPORADOR MAS EFICIENTE DEL MERCADO, MENOR GASTO ENERGÉTICO, MAYOR PRODUCCIÓN DE HIELO
- ▶ THERMOSTATIC EXPANSION VALVE / LIQUID SOLENOID VALVE / STOP WHEN FULL BIN STOP WITH PHOTOELECTRICAL SENSOR
VÁLVULA DE EXPANSIÓN TERMOSTÁTICA / VÁLVULA SOLENOIDE DE LÍQUIDO / PARO POR LLENADO DE CUBA CON CÉLULA FOTOELÉCTRICA
- ▶ ELECTRONIC STOP SYSTEM / ELECTRICAL CONTROL PANEL / DRIVE DIRECT GEAR MOTOR / MAGNETIC DRIVE PUMP / LOW WATER SAFETY DEVICE
SISTEMA DE PARO ELECTRÓNICO / CUADRO ELÉCTRICO DE REGULACIÓN / MOTORREDUCTOR DE ATAQUE DIRECTO / BOMBA DE ARRASTRE MAGNÉTICO / SEGURIDAD ANTE FALTA DE AGUA
- ▶ STAINLESS STEEL SOLEPLATE
BANCADA DE ACERO INOXIDABLE
- ▶ CONTROLLERS TO DETECT: LOW WATER LEVEL, TEMPERATURE RISE DUE TO MOTOR OVERLOAD OR FULL VAT
CONTROLES PARA DETECTAR: FALTA DE NIVEL DE AGUA, AUMENTO DE TEMPERATURA POR SOBRESFUERZO EN EL MOTORREDUCTOR O POR LLENADO DE ALMACÉN

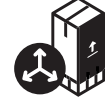

	 24 H	 10°C	 10°C	 21°C	 15°C	 (mm)	 (mm)	
SC 400 SPLIT		450	400	Width 1.090 Depth 700 Height 760	Width 1.220 Depth 820 Height 915	FLAKE ICE -7°C Ice Temperature		

ACCESSORIES ACCESORIOS

INCLUDED



WATER INLET FILTER GASKET
JUNTA DE FILTRO DE ENTRADA DE AGUA



WATER INLET HOSE
MANGUERA DE ENTRADA DE AGUA



WATER OUTLET HOSE
MANGUERA DE DESAGÜE

NOT INCLUDED (OPTIONAL)



ICE DROP CHUTE
TUBO DE CAÍDA DE HIELO



SALT DOSING PUMP WITH TANK
BOMBA DOSIFICADORA DE SAL CON DEPÓSITO



REMOTE SWITCH FILTER
INTERRUPTOR REMOTO



REMOTE SWITCH & WEEKLY PROGRAMMER
INTERRUPTOR REMOTO CON PROGRAMADOR SEMANAL



EXTERNAL STOP FULL BIN PHOTO CELL
SENSOR DE PARO EXTERNO POR LLENADO

RECOMMENDED BINS DEPÓSITOS RECOMENDADOS



B400 + SCALA 400 SPLIT



B500 + SCALA 400 SPLIT



BCD400 + SCALA 400 SPLIT



BCD600 + SCALA 400 SPLIT



BCD800 + SCALA 400 SPLIT

SC 400 SPLIT

RIGHT SIDE VIEW
VISTA LATERAL DERECHA

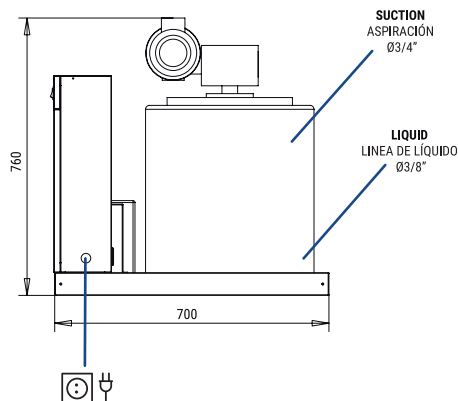

FRONTAL VIEW
VISTA FRONTAL

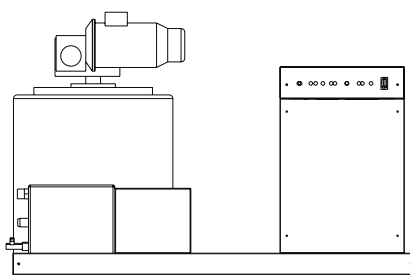

LEFT SIDE VIEW
VISTA LATERAL IZQUIERDA

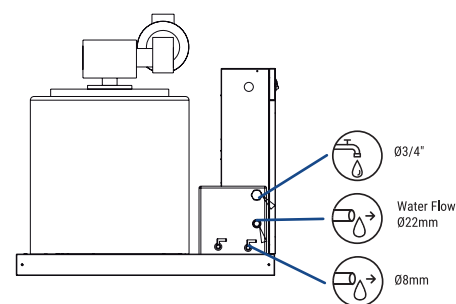

CENTRAL CROSS SECTION VIEW OF THE BASE
VISTA DE LA BASE DESDE SECCIÓN CENTRAL

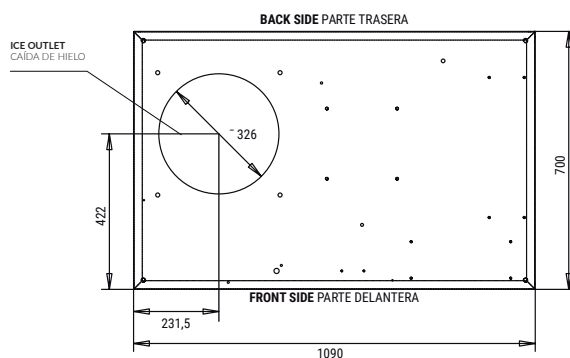

* All measurements in mm.
* Todas las cotas en mm.

OPERATING CONDITIONS CONDICIONES DE OPERACIÓN

PRODUCTION 50-60Hz PRODUCCIÓN 50-60 Hz

±10% V

10°C/43°C

5°C/38°C

1 bar/6 bar

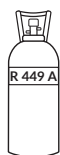

V	Hz	ph
230	50-60	1N

Kg 24 H	SC 400 SPLIT				
	10° 50°	15° 60°	21° 70°	30° 86°	
1'5-2'2 mm	450	420	350	310	
	440	400	335	290	
	410	360	300	260	
	335	290	230	200	

Kg 24 H	SC 400 SPLIT				
	10° 50°	15° 60°	21° 70°	30° 86°	
3 mm	419	391	326	288	
	409	372	312	270	
	381	335	279	242	
	312	270	214	186	

MODELS
MODELOS

SC 400 S

	Temp.EV. (°C)	ASHRAE CONDITIONS CONDICIONES ASHRAE (W) (BTu/h)	(W) 43°C	(n.) (mm ²)	FUSE	100 Kg (Kw/h)	(l/h)	HEAT REJECTED (W) (BTu/h)	(Kg)	(Kg)	(m ³)
SC 400 S	-22	2.200 7.507	190	3 1,5	16	7,5*	16,6	- -	100	127	0,92

* WHEN INDICATED COOL REQUIREMENT IS SUPPLIED / CUANDO SE SUMINISTRA LA POTENCIA FRIGORÍFICA REQUERIDA



ICETECH, S.A.
POL. IND. LA REVA, SECTOR 13, AV. GREMIS, 1
46394 RIBARROJA DE TURIA, VALENCIA, SPAIN
PHONE: +34 961 667 636 FAX: +34 961 668 944
sales@icetechice.com | www.icetechice.com



SERVICE
SERVICIO ASISTENCIA TÉCNICA
sales@icetechice.com
Skype: ICETECH.Service
+34 961 667 639
8:00AM | 7:00PM



Subject to certain limitations
and exclusions. Only spare parts.
Sujeto a limitaciones y exclusiones.
Solo piezas de repuesto



9001
14001

