









SC 50000 SPLIT THREE PHASE 400 V / 50-60 Hz

MODULAR FLAKE ICE MACHINE SPLIT

FEATURES CARATTERISTICHE

- ▶ **PRODUCES COLD AND DRY FLAT FLAKES. FLAKE THICKNESS MAY BE ADJUSTED BETWEEN 1.5 mm AND 3 mm.**
PRODUCE SCAGLIE PIANE MOLTO FREDDI E ASCIUTTE. LO SPESSORE È REGOLABILE DA 1.5 A 3 mm.
- ▶ **BASED ON A STATIC CYLINDER WHICH IS FREE FROM SWIVEL JOINTS (HELICAL REAMER) COUPLED WITH A MILLING TOOL THAT DETACHES THE ICE WITHOUT ANY STRAINED OR FORCED MOVEMENTS.**
FUNZIONAMENTO BASATO SU UN CILINDRO STATICO SENZA GIUNTI ROTANTI (ALESATORE ELICOIDALE) E CON UNA FRESA CHE STACCA IL GHIACCIO SENZA TENSIONE O SFORZO.
- ▶ **THE MOST EFFICIENT EVAPORATOR OF THE MARKET, LESS ENERGY CONSUMPTION AND HIGHER ICE PRODUCTION.**
L'EVAPORATORE PIÙ EFFICIENTE SUL MERCATO, CONSUMO ENERGETICO MINORE, MAGGIORE PRODUZIONE DI GHIACCIO.
- ▶ **ELECTRONIC STOP SYSTEM / ELECTRICAL CONTROL PANEL / DRIVE DIRECT GEAR MOTOR / MAGNETIC DRIVE PUMP / LOW WATER SAFETY DEVICE.**
SISTEMA ELETTRONICO DI ARRESTO / PANNELLO DI CONTROLLO ELETTRICO / MOTORIDUTTORE CON TRASMISSIONE DIRETTA / POMPA A TRASCINAMENTO MAGNETICO / DISPOSITIVO DI SICUREZZA IN CASO DI MANCANZA DI ACQUA.
- ▶ **STAINLESS STEEL SOLEPLATE.**
PIASTRA IN ACCIAIO INOSSIDABILE.
- ▶ **CONTROLLERS TO DETECT: LOW WATER LEVEL, TEMPERATURE RISE DUE TO MOTOR OVERLOAD OR FULL VAT.**
DISPOSITIVI PER RILEVARE: MANCANZA DI ACQUA, AUMENTO DELLA TEMPERATURA A CAUSA DEL SOVRACCARICO DEL MOTORE O PER RIEMPIMENTO DELLA VASCHETTA.
- ▶ **ELECTRONIC EXPANSION VALVE / SUCTION REGULATING VALVE / STOP WHEN FULL BIN STOP WITH PHOTOELECTRICAL SENSOR.**
VALVOLA AD ESPANSIONE ELETTRONICA / VALVOLA DI REGOLAZIONE DELL'ASPIRAZIONE / ARRESTO PER RIEMPIMENTO DELLA VASCHETTA CON CELLULA FOTOELETTRICA.



	 24 H	 10°C (Kg)	 15°C (Kg)	 (mm)	 (mm)	
SC 50000 SPLIT 		55.000	50.000	Width 2.135 Depth 3.100 Height 3.300	Width 2.235 Depth 3.200 Height 3.555	FLAKE ICE -7°C Ice Temperature

ACCESSORIES ACCESSORI

NOT INCLUDED (OPTIONAL)



SALT DOSING PUMP WITH TANK
 BOMBA DOSATORE DI SALE CON SERBATOIO



REMOTE SWITCH
 INTERRUPTORE REMOTO



REMOTE SWITCH & WEEKLY PROGRAMMER
 INTERRUPTORE REMOTO CON TIMER SETTIMANALE



EXTERNAL STOP FULL BIN PHOTO CELL
 SENSORE DI ARRESTO ESTERNO PER RIEMPIMENTO

RECOMMENDED BINS SERBATOI RACCOMANDATI



BS422 + SC 50000 SPLIT



BS623 + SC 50000 SPLIT



BS732 + SC 50000 SPLIT



BS1132 + SCZ 50000 SPLIT

SC 50000 SPLIT

RIGHT SIDE VIEW
VISTA LATERALE DESTRA

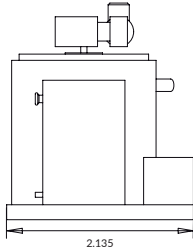

FRONTAL VIEW
VISTA FRONTALE

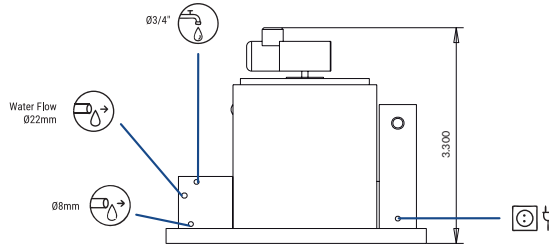

LEFT SIDE VIEW
VISTA LATERALE SINISTRO

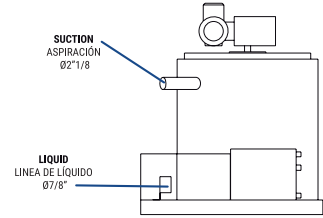

CENTRAL CROSS SECTION VIEW OF THE BASE
VISTA DELLA BASE DALLA ZONA CENTRALE

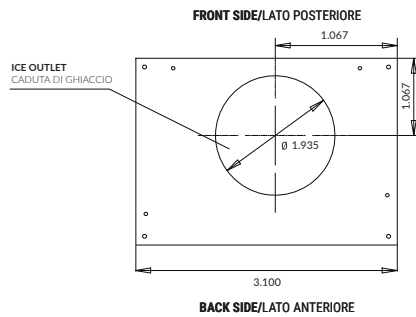

* All measurements in mm.
* Tutte le misure in mm.

OPERATING CONDITIONS CONDIZIONI PER IL FUNZIONAMENTO

PRODUCTION 50-60Hz PRODUZIONE 50-60 Hz

Icon	Value	SC 50000 SPLIT					SC 50000 SPLIT				
		10°	15°	21°	30°	10°	15°	21°	30°		
±10% V											
10°C/43°C		55000	52143	45000	41429	51150	48493	41850	39529		
5°C/38°C		54429	50000	42857	39286	50619	46500	39857	36536		
1 bar/6 bar		51429	46429	40000	36000	47829	43179	37200	33480		
		43571	39286	32857	30000	40521	36536	30557	27900		

MODELS MODELLI	Temp.EV. (°C)	ASHRAE CONDITIONS CONDIZIONI ASHRAE (W) (BTu/h)	(W) 43°C	(n.) (mm²)	FUSE	100 Kg (Kw/h)	(l/h)	HEAT REJECTED (W) (BTu/h)	(Kg)	(Kg)	(m³)
SC 50000 S	-22	275.000 938.339	1.170	5 1,5	16	-*	2.083	- -	5.500	5.600	25,4

* WHEN INDICATED COOL REQUIREMENT IS SUPPLIED / QUANDO VIENE FORNITA LA POTENZA FRIGORIFERA RICHIESTA.

0000_ict/emt_21/E/21



ICETECH, S.A.
POL. IND. LA REVA, SECTOR 13, AV. GREMIS, 1
46394 RIBARROJA DE TURIA, VALENCIA, SPAIN
PHONE: +34 961 667 636 | FAX: +34 961 668 944
sales@icetechice.com | www.icetechice.com



SERVICE
SERVIZIO ASSISTENZA TECNICA
sales@icetechice.com
Skype: ICETECH.Service
+34 961 667 639
8:00AM | 7:00PM



Subject to certain limitations and exclusions. Only spare parts.
Soggetta a limitazioni e revoca.
Solo parti di ricambio.



9001
14001

