

PS 22











230 V / 50 Hz

SELF-CONTAINED ICE CUBE MACHINE

FEATURES CARACTERÍSTICAS

- ▶ **PADDLE SYSTEM TO PRODUCE ICE IN THE MOST ADVERSE CONDITIONS OF WATER QUALITY (HARDWATER) AND IN THE LEAST ADEQUATE SITES.**
SISTEMA DE PALETAS QUE PERMITE FABRICAR HIELO EN LAS CONDICIONES MÁS ADVERSAS DE CALIDAD DE AGUA (AGUA DURA) Y EN LOS EMPLAZAMIENTOS MENOS ADECUADOS.
- ▶ **PADDLE SYSTEM THAT MAKES WATER FILTERS UNNECESSARY, AVOIDING THEIR COSTS.**
SISTEMA DE PALETAS QUE HACE INNECESARIOS LOS FILTROS DE AGUA, EVITANDO SUS COSTES.
- ▶ **WATER MOVEMENT THANKS TO PADDLES GRANTS THAT THE PUREST WATER TOUCHES THE EVAPORATOR AND GET FROZEN, OBTAINING THE CLEAREST ICE CUBE.**
EL MOVIMIENTO DEL AGUA GRACIAS A LAS PALETAS GARANTIZA QUE EL AGUA MÁS PURA TOQUE EL EVAPORADOR, OBTENIENDO EL CUBITO MÁS CLARO.
- ▶ **DESIGNED WITHOUT THERMOSTAT, AVOIDING PROBLEMS & GETTING ALL ICE IS POSSIBLE.**
DISEÑADA SIN TERMOSTAT, SE EVITAN PROBLEMAS Y SE OBTIENE TODO EL HIELO POSIBLE.
- ▶ **WITHOUT TIMER. DETECTION OF END OF CYCLE AND FULL BIN ARE DETECTED THROUGH MECHANICAL DEVICES.**
SIN TEMPORIZADOR, SE DETECTA EL FINAL DEL CICLO DE HIELO Y EL LLENADO DEL ALMACEN A TRAVÉS DE DISPOSITIVOS MECÁNICOS.
- ▶ **SIMPLE AND RELIABLE MANUFACTURING DESIGN.**
DISEÑO DE FABRICACIÓN SENCILLO Y FIABLE.
- ▶ **PRODUCES A SEMI-HOLLOW CUBE WITH A GREATER SURFACE THAT COOLS FASTER THE DRINK.**
PRODUCE UN CUBITO SEMIHUECO CON UNA MAYOR SUPERFICIE QUE ENFRÍA MÁS RÁPIDO LA BEBIDA.
- ▶ **DOOR-OPENING MOVEMENT DAMPENING SYSTEM TO AVOID ACCIDENTS.**
APERTURA DE PUERTA HACIA DENTRO PARA EVITAR ACCIDENTES.
- ▶ **ON/OFF LIGHTED ROCKER SWITCH IN FRONT PANEL.**
INTERRUPTOR LUMINOSO DE FUNCIONAMIENTO ON/OFF EN EL PANEL FRONTAL.
- ▶ **AISI 304 STAINLESS STEEL FRAME.**
CARROCERÍA EN ACERO INOXIDABLE AISI 304.
- ▶ **TROPICALIZED MACHINES (T CLASS).**
MÁQUINAS TROPICALIZADAS (CLASE T).



	 24 H	 10°C (Kg)	 10°C (Kg)	 21°C (Kg)	 15°C (Kg)	 STOCK (Kg)	 (mm)	 (mm)	
PS 22 A		24	22	6	6	Width 401 Depth 506 Height 643*	Width 495 Depth 605 Height 760	PS 20cc 29 (Ø) x 42 mm (H) Average dimensions Dimensiones promedio	
PS 22 W		27	24						

* WITH LEGS 700 CON PATAS 700

ACCESSORIES ACCESORIOS

INCLUDED



WATER INLET HOSE
MANGUERA DE ENTRADA DE AGUA



WATER OUTLET HOSE
MANGUERA DE DESAGÜE



4 LEG KIT
KIT 4 PATAS



WATER INLET FILTER GASKET
JUNTA DE FILTRO DE ENTRADA DE AGUA



SMALL SCOOP
PALA PEQUEÑA

NOT INCLUDED (OPTIONAL)



ANTI-LIMESCALE FILTER
FILTRO ANTICAL



C4 WATER SOFTENER
DESCALCIFICADOR C4



ANTI-LIMESCALE + ANTI-CHLORINE FILTER CS101
FILTRO ANTICAL + ANTICLORO CS101



CALKLIN 50 CLEANER
PRODUCTO ANTICAL



PARTICLE FILTER
FILTRO ANTIPARTÍCULAS



ANTI-CHLORINE FILTER
FILTRO ANTICLORO

RIGHT SIDE VIEW
VISTA LATERAL DERECHA

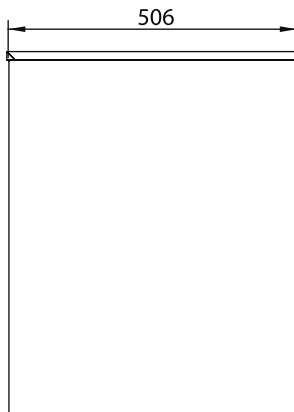

FRONTAL VIEW
VISTA FRONTAL

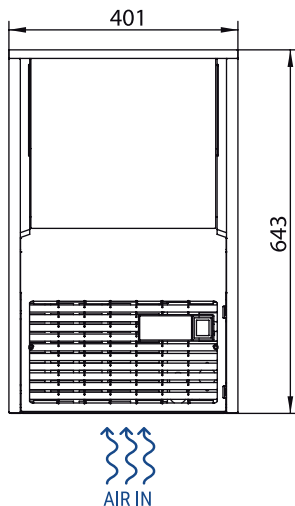

REAR VIEW
VISTA TRASERA

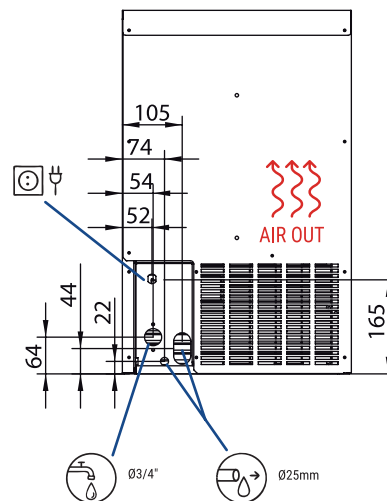

* All measurements in mm.
* Todas las cotas en mm.

OPERATING CONDITIONS CONDICIONES DE OPERACIÓN

PRODUCTION 50Hz PRODUCCIÓN 50 Hz

±10% V

5°C/43°C

5°C/35°C

1 bar/6 bar

15 Ice cubes/cycle

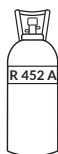

V	Hz	ph
230	50	1N



PS 22 AIR COOLED

	°C				
	10°	15°	21°	30°	
°F	50°	60°	70°	86°	
10°	24	23	22	20	
50°					
21°	23	22	20	19	
68°					
32°	19	18	15	14	
90°					
43°	14	12	9	7	
109°					



PS 22 WATER COOLED

	°C				
	10°	15°	21°	30°	
°F	50°	60°	70°	86°	
10°	27	25	23	21	
50°					
21°	26	24	22	20	
68°					
32°	25	23	21	19	
90°					
43°	24	22	21	19	
109°					

MODELS
MODELOS

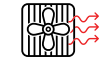

	(W)	(BTu/h)	(W) 43°C	(n.)	(mm ²)	FUSE	(Kwh)	(l/h)	(W)	(BTu/h)	(Kg)	(Kg)	(m ³)
PS 22 A	758	2.586	287	3	1,5	10	22,8	4,2	530	1.808	36	40	0,23
PS 22 W	758	2.586	189	3	1,5	10	18	16,9	530	1.808	36	40	0,23