

PS 42











230 V / 50 Hz

SELF-CONTAINED ICE CUBE MACHINE

FEATURES CARACTERÍSTICAS

- ▶ **PADDLE SYSTEM TO PRODUCE ICE IN THE MOST ADVERSE CONDITIONS OF WATER QUALITY (HARDWATER) AND IN THE LEAST ADEQUATE SITES.**
SISTEMA DE PALETAS QUE PERMITE FABRICAR HIELO EN LAS CONDICIONES MÁS ADVERSAS DE CALIDAD DE AGUA (AGUA DURA) Y EN LOS EMPLAZAMIENTOS MENOS ADECUADOS.
- ▶ **PADDLE SYSTEM THAT MAKES WATER FILTERS UNNECESSARY, AVOIDING THEIR COSTS.**
SISTEMA DE PALETAS QUE HACE INNECESARIOS LOS FILTROS DE AGUA, EVITANDO SUS COSTES.
- ▶ **WATER MOVEMENT THANKS TO PADDLES GRANTS THAT THE PUREST WATER TOUCHES THE EVAPORATOR AND GET FROZEN, OBTAINING THE CLEAREST ICE CUBE.**
EL MOVIMIENTO DEL AGUA GRACIAS A LAS PALETAS GARANTIZA QUE EL AGUA MÁS PURA TOQUE EL EVAPORADOR, OBTENIENDO EL CUBITO MÁS CLARO.
- ▶ **DESIGNED WITHOUT THERMOSTAT, AVOIDING PROBLEMS & GETTING ALL ICE IS POSSIBLE.**
DISEÑADA SIN TERMOSTATO, SE EVITAN PROBLEMAS Y SE OBTIENE TODO EL HIELO POSIBLE.
- ▶ **WITHOUT TIMER. DETECTION OF END OF CYCLE AND FULL BIN ARE DETECTED THROUGH MECHANICAL DEVICES.**
SIN TEMPORIZADOR, SE DETECTA EL FINAL DEL CICLO DE HIELO Y EL LLENADO DEL ALMACEN A TRAVÉS DE DISPOSITIVOS MECÁNICOS.
- ▶ **SIMPLE AND RELIABLE MANUFACTURING DESIGN.**
DISEÑO DE FABRICACIÓN SENCILLO Y FIABLE.
- ▶ **PRODUCES A SEMI-HOLLOW CUBE WITH A GREATER SURFACE THAT COOLS FASTER THE DRINK.**
PRODUCE UN CUBITO SEMIHUECO CON UNA MAYOR SUPERFICIE QUE ENFRÍA MÁS RÁPIDO LA BEBIDA.
- ▶ **DOOR-OPENING MOVEMENT DAMPENING SYSTEM TO AVOID ACCIDENTS.**
APERTURA DE PUERTA HACIA DENTRO PARA EVITAR ACCIDENTES.
- ▶ **ON/OFF LIGHTED ROCKER SWITCH IN FRONT PANEL.**
INTERRUPTOR LUMINOSO DE FUNCIONAMIENTO ON/OFF EN EL PANEL FRONTAL.
- ▶ **AISI 304 STAINLESS STEEL FRAME.**
CARROCERÍA EN ACERO INOXIDABLE AISI 304.
- ▶ **TROPICALIZED MACHINES (T CLASS).**
MÁQUINAS TROPICALIZADAS (CLASE T).



	 24 H	 10°C (Kg)	 10°C (Kg)	 21°C (Kg)	 15°C (Kg)	 STOCK (Kg)	 (mm)	 (mm)	
PS 42 A		38	38	12	Width 401 Depth 506 Height 698*	Width 500 Depth 605 Height 815		PS 20cc 29 (Ø) x 42 mm (H) Average dimensions Dimensiones promedio	
PS 42 W		44	39						

* WITH LEGS 755 CON PATAS 755

ACCESSORIES ACCESORIOS

INCLUDED



WATER INLET HOSE
MANGUERA DE ENTRADA DE AGUA



WATER OUTLET HOSE
MANGUERA DE DESAGÜE



4 LEG KIT
KIT 4 PATAS



WATER INLET FILTER GASKET
JUNTA DE FILTRO DE ENTRADA DE AGUA



SMALL SCOOP
PALA PEQUEÑA

NOT INCLUDED (OPTIONAL)



ANTI-LIMESCALE FILTER
FILTRO ANTICAL



C4 WATER SOFTENER
DESCALCIFICADOR C4



ANTI-LIMESCALE + ANTI-CHLORINE FILTER CS101
FILTRO ANTICAL + ANTICLORO CS101



CALKLIN 50 CLEANER
PRODUCTO ANTICAL



PARTICLE FILTER
FILTRO ANTIPARTÍCULAS



ANTI-CHLORINE FILTER
FILTRO ANTICLORO

RIGHT SIDE VIEW
VISTA LATERAL DERECHA

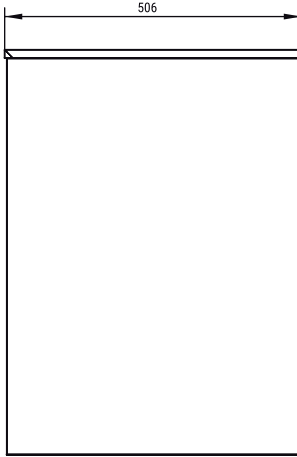

FRONTAL VIEW
VISTA FRONTAL

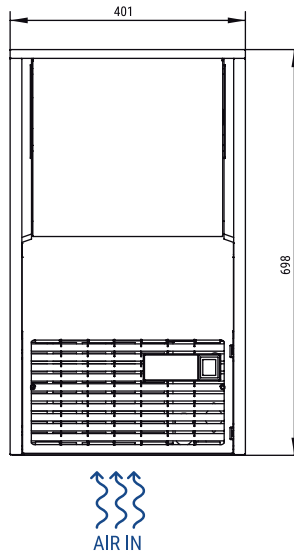

REAR VIEW
VISTA TRASERA

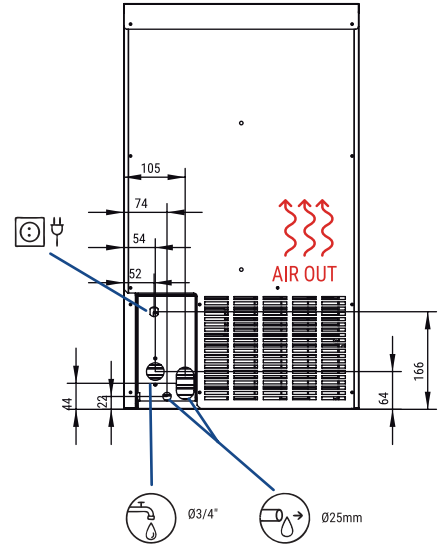

* All measurements in mm.
* Todas las cotas en mm.

OPERATING CONDITIONS CONDICIONES DE OPERACIÓN

PRODUCTION 50Hz PRODUCCIÓN 50 Hz

±10% V

5°C/43°C

5°C/35°C

1 bar/6 bar

25 Ice cubes/cycle

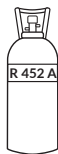

V	Hz	ph
230	50	1N

PS 42 AIR COOLED

	°C			
	10°	15°	21°	30°
°F	50°	60°	70°	86°
10°	38	35	33	31
50°				
21°	40	38	35	33
68°				
32°	32	29	27	24
90°				
43°	22	18	15	13
109°				

PS 42 WATER COOLED

	°C			
	10°	15°	21°	30°
°F	50°	60°	70°	86°
10°	44	41	38	35
50°				
21°	42	39	36	33
68°				
32°	39	36	34	31
90°				
43°	37	34	32	29
109°				

MODELS
MODELOS

PS 42 A

PS 42 W

	+c° -c°	ASHRAE CONDITIONS CONDICIONES ASHRAE	(W)	(BTu/h)	(W) 43°C	(n.)	(mm ²)	FUSE	100 Kg (Kwh)	(l/h)	HEAT REJECTED (W)	(BTu/h)	(Kg)	(Kg)	(m ³)
PS 42 A			966	3.296	421	3	1,5	10	20	5,5	731	2.494	40	45	0,25
PS 42 W			966	3.296	306	3	1,5	10	18,5	24,2	731	2.494	40	45	0,25